

# Order BOMs (PP-BD-BOM)



HELP.PPOBOM

**Release 4.6C**



## Copyright

© Copyright 2000 SAP AG. All rights reserved.

No part of this brochure may be reproduced or transmitted in any form or for any purpose without the express permission of SAP AG. The information contained herein may be changed without prior notice.

Some software products marketed by SAP AG and its distributors contain proprietary software components of other software vendors.

Microsoft®, WINDOWS®, NT®, EXCEL®, Word® and SQL Server® are registered trademarks of Microsoft Corporation.

IBM®, DB2®, OS/2®, DB2/6000®, Parallel Sysplex®, MVS/ESA®, RS/6000®, AIX®, S/390®, AS/400®, OS/390®, and OS/400® are registered trademarks of IBM Corporation.

ORACLE® is a registered trademark of ORACLE Corporation, California, USA.

INFORMIX®-OnLine for SAP and Informix® Dynamic Server™ are registered trademarks of Informix Software Incorporated.

UNIX®, X/Open®, OSF/1®, and Motif® are registered trademarks of The Open Group.







HTML, DHTML, XML, XHTML are trademarks or registered trademarks of W3C®, World Wide Web Consortium, Laboratory for Computer Science NE43-358, Massachusetts Institute of Technology, 545 Technology Square, Cambridge, MA 02139.

JAVA® is a registered trademark of Sun Microsystems, Inc., 901 San Antonio Road, Palo Alto, CA 94303 USA.

JAVASCRIPT® is a registered trademark of Sun Microsystems, Inc., used under license for technology invented and implemented by Netscape.

SAP, SAP Logo, mySAP.com, mySAP.com Marketplace, mySAP.com Workplace, mySAP.com Business Scenarios, mySAP.com Application Hosting, WebFlow, R/2, R/3, RIVA, ABAP, SAP Business Workflow, SAP EarlyWatch, SAP ArchiveLink, BAPI, SAPPHIRE, Management Cockpit, SEM, are trademarks or registered trademarks of SAP AG in Germany and in several other countries all over the world. All other products mentioned are trademarks or registered trademarks of their respective companies.

## Icons

Icon	Meaning
	Caution
	Example
	Note
	Recommendation
	Syntax
	Tip

## Contents

<b>Order BOMs (PP-BD-BOM)</b> .....	<b>7</b>
Order BOM.....	9
Hints on Terminology.....	11
Sales Order Processing for Products with Many Variants (Desc.).....	12
Sales Order Processing for Products with Many Variants (Struct.).....	14
Sales Order Processing with Engineer-to-Order Production.....	17
Assemblies with a Long Replenishment Lead Time.....	21
Detached Order Assembly.....	23
Example: Detached Order Assembly.....	25
Create Detached Order Assembly.....	28
Inserting a Detached Order Assembly.....	29
Entering a Sales Order.....	30
Blocking Requirements.....	32
Creating an Order BOM.....	33
Order BOMs for Variant Configuration.....	34
Example: Order BOMs in Variant Configuration.....	36
Settings in the Configuration Profile.....	38
Creating a Knowledge-Based Order BOM.....	39
Creating a Result-Oriented Order BOM.....	41
Instantiating Configurable Materials.....	43
Fixing Configurable Assemblies.....	46
Merging with Global Material BOMs.....	49
Order Browser.....	51
Creating Order BOMs without Configuration.....	52
Create an Order BOM.....	53
Example: Creating Without Variant Configuration.....	55
Working with the Order Browser and Order Analysis.....	57
Navigation in the Order Browser.....	59
Calling up the Browser.....	61
Variable Display Depth.....	63
Display Log.....	65
Engineering Change Management in the Order Browser.....	66
Order Analysis.....	67
Material Exchange in the Order Browser.....	69
Material Exchange.....	70
Fixing a BOM in the Order Browser.....	71
Fixing a BOM in the Order Browser.....	72
Example: Multi-Level Fixing in the Order Browser.....	74
Multi-Level Copying.....	76
Copying a BOM Level by Level.....	78
Order BOM Editing.....	79
Changing an Order BOM.....	80
Displaying Order Bills of Material.....	81
Transferring BOMs to the Project System.....	82

<b>Multi-Level Order BOM Reporting.....</b>	<b>83</b>
BOM Explosion.....	84
Displaying BOMs Level by Level.....	85
Displaying a Multi-Level BOM Explosion .....	87
Displaying a Summarized BOM .....	89
Where-Used Lists .....	90
BOM Comparison .....	91
<b>Order-Specific Component Assignment in Routings .....</b>	<b>92</b>
<b>Costing of Order BOMs.....</b>	<b>94</b>
<b>Sales Order Costing .....</b>	<b>95</b>
Product Cost Estimates for Sales Order Items .....	102
Manually Creating a Product Cost Estimate for a Sales Order Item .....	107
<b>Order BOM Cost Estimates.....</b>	<b>109</b>
Order BOM Cost Estimates.....	110
Creating and Marking an Order BOM Cost Estimate.....	113
<b>Blocking Requirements.....</b>	<b>115</b>
<b>Order BOMs in MRP .....</b>	<b>116</b>
<b>Plan Material Requirements for Detached Order Assemblies .....</b>	<b>118</b>
<b>Plan Material Requirements for Sales Order Items .....</b>	<b>120</b>
<b>Order BOMs in Production .....</b>	<b>121</b>
<b>Enhancements to the SAP Systems in the Area of PLM .....</b>	<b>122</b>
<b>Enhancements in Document Management .....</b>	<b>125</b>
Enhancements using Customer Exits (Document) .....	126
Finding Recipient Lists (EXIT_SAPLCVV1_001).....	128
Screen: Basic Data for Maintaining Documents .....	129
Screen: Recipient Lists (EXIT_SAPLCVV1_002) .....	130
Determine Original Application File (EXIT_SAPLCVV1_003).....	133
Document Part and Version (EXIT_SAPLCVV1_004) .....	135
Create Distribution Order (EXIT_SAPLCVV2_001) .....	136
Check Part Order (EXIT_SAPLCVV2_002) .....	137
Create Initial Order (EXIT_SAPLCVV2_003).....	138
Determine Context (EXIT_SAPLCVV5_001) .....	139
ITS Access (EXIT_SAPLCVWV_001).....	141
Determining the Application (EXIT_SAPLCVV1_005) .....	142
Enhancements using Business Add-Ins (Document) .....	143
Checking Authorization from the Document Management Systems .....	145
Processing of Original Application Files.....	146
General Document Processing .....	148
General Document Processing (II).....	149
Status checks .....	150
Transport of Original Application Files .....	151
Checking the Attributes of the Document Key .....	152
Filter for DMS processes.....	153
Enhancements for Internet Scenarios.....	154
Enhancements for Microsoft Office integration .....	155
Enhancements using User Exits (Document) .....	156

<b>Enhancements Using Customer Exits (Material Master)</b> .....	<b>158</b>
<b>Enhancements in the Area Engineering Change Management</b> .....	<b>160</b>
<b>Enhancements in BOMs</b> .....	<b>162</b>
Enhancements Using Customer Exits (BOMs) .....	163
Enhancements using Business Transaction Events (BOMs).....	165
Update of a BOM (CS000010) .....	166
<b>Enhancements in the Classification System</b> .....	<b>167</b>
<b>Enhancements in Variant Configuration</b> .....	<b>169</b>
<b>WBS BOM Browser</b> .....	<b>172</b>
<b>Navigation in the WBS BOM Browser</b> .....	<b>173</b>
Calling Up the Browser from the Project Info System .....	175
Calling up the Browser .....	176
Variable Display Depth .....	178
Display Log .....	180
<b>Analysis</b> .....	<b>181</b>
<b>Material Exchange in the WBS BOM Browser</b> .....	<b>182</b>
Material Exchange .....	183
<b>Fixing a BOM in the WBS BOM Browser</b> .....	<b>184</b>
<b>Processing a Single-Level WBS BOM</b> .....	<b>185</b>
<b>BOM Transfer</b> .....	<b>186</b>

## Order BOMs (PP-BD-BOM)

### Purpose

In the course of improving customer focus, it is ever more important for businesses working with make-to-order production, to be able to react quickly and flexibly to the wishes of the customer. The majority of products, particularly in plant engineering and construction and mechanical engineering, are very complex and customer specific. In response to customer requirements postprocessing of the BOMs in the construction is often required. Often assemblies are also constructed from scratch for a customer.

### Implementation considerations

Order BOMs can be used in various commercial processes. In this documentation two sample processes are described, in order to demonstrate the different purposes. Naturally elements of the two processes can be combined.

- You create a product with many variants and work with the variant configuration. You create an order BOM in order to react to the special wishes of the customer, which you can not foresee in your configuration model. For single assemblies extra construction products may be required.

**See:**

[Sales order processing for products with many variants \[Page 12\]](#)

- You create complex products for large, capital-intensive projects, such as those in plant engineering and construction. Each of your products is a unique specimen, specially constructed to meet the requirements of your customers. For different core components, you use material BOMs that you partly modify for a specific order. However, for each sales order, you also construct a part of the assemblies from scratch.

**See:**

[Sales order processing with engineer-to-order production \[Page 17\]](#)

### Integration

Order BOMs are supported in the following components:

- SD - Sales
- LO – Variant Configuration
- LO – Engineering Change Management
- PP – Routings
- PS – Project System
- CO – Costing
- PP – Requirements planning
- PP – Production orders

---

**Order BOMs (PP-BD-BOM)****Features**

All changes, carried out by the design team, to fulfil the customer requirements for an assembly, are saved in an order BOM. The material BOMs of the standard product are not changed. This allows the design the greatest possible freedom with the customer-specific development.

Furthermore, order BOMs guarantee total integration into the logistics value chain. An assembly that has been specially designed or changed for a customer, is uniquely identified in the logistics processes with sales order, sales order item and material.

You can create order BOMs for either configurable or non-configurable assemblies. During the integration of variant configuration and order BOMs, it is guaranteed that you can process, in the order browser, an order BOM, for example, which you created in variant configuration.

In the order browser you get an overview of the multi-level BOMs of a sales order item and you can navigate to the various process and evaluation functions for order BOMs.



## Order BOM

### Definition

A bill of material, which is generated from a material BOM and is modified for a specific sales order. The material BOM, however, does not change.

An order BOM is generated when a material BOM is changed for a specific order.

### Use

You use an order BOM if you want to change the bill of material for a material, to meet the requirements of a single sales order. Since the changes only affect this one sales order, you do not want to change the material BOM. However, you do not want to maintain any new material master records either.



For example, as a make-to-order manufacturer, you supply complex products with numerous variants. To do this, you use variant configuration in the SAP System. However, since each customer has different requirements, you cannot plan all product variants in advance. In these cases, you generate order BOMs in variant configuration. You can then modify these order BOMs to completely fulfill the customers' product requirements.

### Structure

An order BOM has the same structure as the material BOM from which it is generated.

A BOM that is created with reference to a specific sales order is described as an order BOM. A sales order number, a sales order item and a material number uniquely identify an order BOM.

Both material BOMs and order BOMs can be contained in the multi-level BOM for the material that you entered in a sales order item.

- Material BOMs are used for order-independent assemblies, in other words, assemblies that are not changed.
- You use order BOMs for assemblies that you change for a specific sales order.

### Example

You have entered material A in a sales order item. The BOM for material A contains components B and C, which are themselves assemblies.

The bill of material for material C is extended for a specific sales order with component H (see graphic). An order BOM is generated from material BOM C.

#### Creating an Order BOM

Order BOM

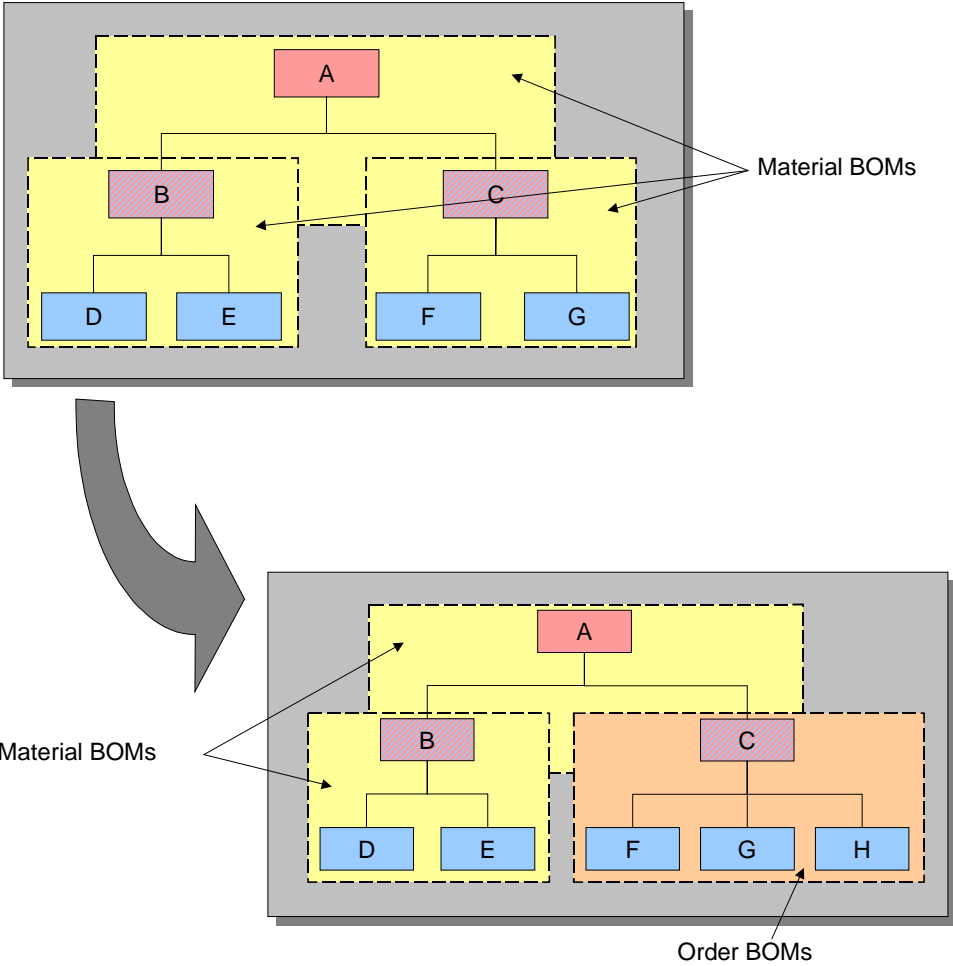

## Hints on Terminology

### Order BOM

The terms [Order BOM \[Ext.\]](#) and *sales order BOM* are interchangeable.

An order BOM is often created by engineering/design, for instance, if you have to redesign an assembly to fulfill customer requirements.



You should not confuse creating an order BOM with changing the component overview in a production order, where it is not the product's bill of material but rather it's components that you change, without altering the material BOM.

The component overview in a production order is often changed by work schedulers, if, for example, a component, which is not available due to a bottleneck, has to be replaced. In this case you do **not** create an order BOM.

### Finished Product, Semi-Finished Product, Raw Material

In this documentation we describe a material that:

- was entered as a *finished product* in a sales order item
- is, as a *semi-finished product*, simultaneously a BOM item and header for an assembly
- is, as a *raw material*, a BOM item but not a header for an assembly

As a rule these descriptions correspond to the material types in the material master record. However, there is not necessarily any relationship between the material type and the use in a multi-level BOM. The material type can differ from the use in a multi-level BOM.

## Sales Order Processing for Products with Many Variants (Desc.)

### Example: Configurable PC

In this example, the sales order processing for a product with many variants is presented with a configurable PC. This is an example of a process, the elements of which are combined with elements from other processes.

### Purpose

As a PC manufacturer you offer your customers the opportunity to determine the configuration of their computer themselves at the point of purchase. Your customers can choose from different variants for specific components such as the processor or the hard disk. You then produce the computer to the individual requirements. To do this, you use variant configuration in the SAP System.

### Sales and Distribution and Technical Post Processing

The processing of a BOM is carried out in two steps:

1. In sales and distribution you carry out the characteristic value assignment on the top level.  
With the help of the object dependencies, the system selects the components that meet this characteristic value.
2. Afterwards you carry out technical post processing.  
Here, you assess the characteristics for the subordinate assemblies. If you want to carry out sales-order-specific modifications to a BOM, you create an order BOM.

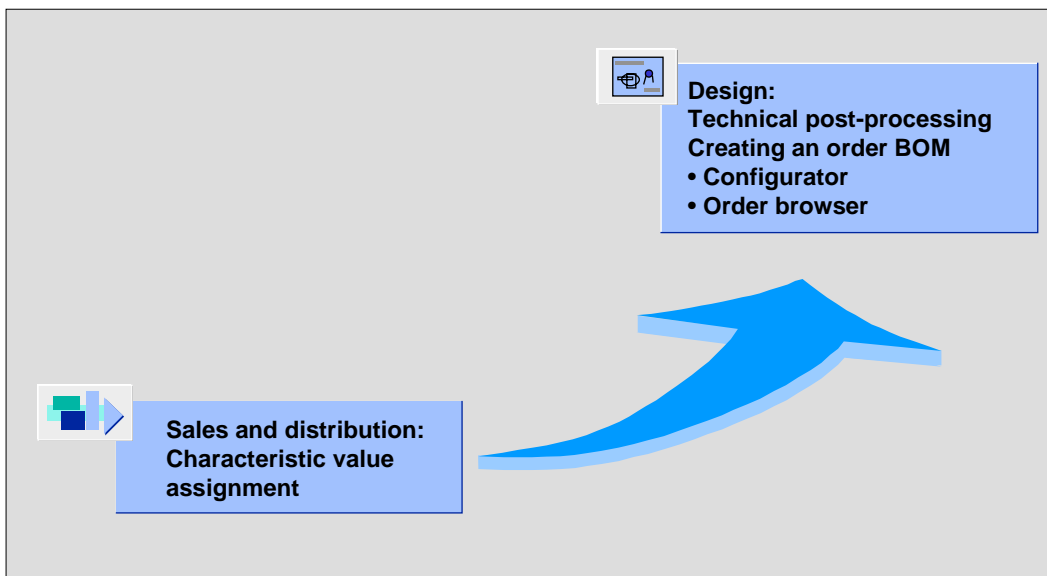

---

**Sales Order Processing for Products with Many Variants (Desc.)**

In future, the master data for the packaging machine PM-1000 will be available in the IDES. Using this example data you can see for yourself the sales order processing for a configurable product with order BOMs.

Note that the order browser, in which you can create order BOMs for non-configurable materials, is available to you after Release 4.6A. In certain circumstances this makes it unnecessary to maintain the phantom configuration profiles.

## Sales Order Processing for Products with Many Variants (Struct.)

### Prerequisites

#### Master data

You have created a super BOM for the configurable PC. Apart from the non-variable parts that exist in all of your PCs, this super BOM also contains variable parts that your customers can choose from:

- In the BOM you have entered more than one processor (CPU), more than one hard disk (HD), and more than one memory module (RAM). These are all variable parts. You have maintained the object dependencies for each of these items.
- Furthermore, you have entered the fan with the material number L-05 in the BOM. This fan is used in all PCs and is not selected in the variant configuration. This is a non-variable part.
- In the configuration profile of the PC, you have defined that order BOMs are saved as result-orientated. Along with the result-orientated order BOM, the configuration result is saved with the manual changes. For more information, see [Creating Result-Oriented Order BOMs \[Page 41\]](#)

#### Super BOM

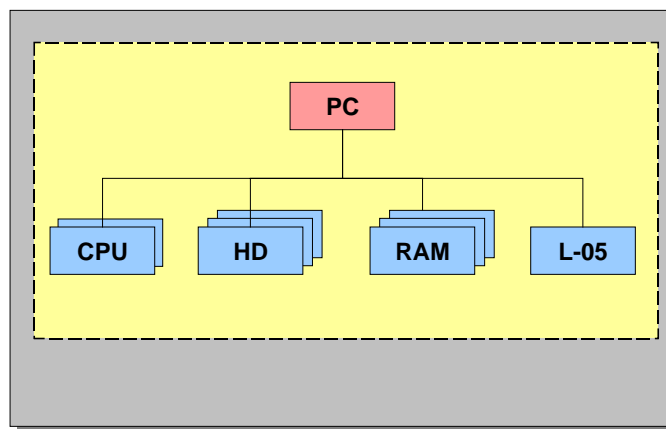

### Process Flow

1. You enter a sales order for the configurable PC.
2. When you enter the sales order, the system asks you to assign the characteristics. You assign the characteristics according to the wishes of the customer.

With the help of the object dependencies, the system automatically selects specific items from the super BOM.



- a. The customer chooses the processor with 550 MHz.

**Sales Order Processing for Products with Many Variants (Struct.)**

- b. The sales employee assigns the characteristic *processor* with "550".
- c. With the help of the object dependencies, the system automatically selects the processor with 550 MHz.

**Super BOM after Characteristic Value Assignment**

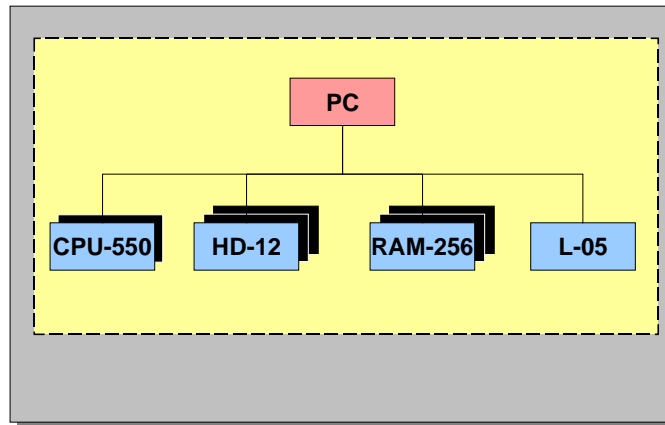

- 3. You save the sales order.

The system saves the characteristic value assignment with the sales order.

- 4. You carry out technical postprocessing of the BOM.

The technician determines that, in certain circumstances, the fan, which you normally install in your computers, is not sufficient for prolonged usage in this computer configuration. Therefore he decides to replace the fan in the computer for this customer, with a stronger one.

Since you only want to install the stronger fan into this PC, you create an order BOM. In the order BOM, you exchange the standard fan for the stronger one with the material number L-20. This change only affects the order BOM for this sales order, the material BOM on the other hand remains unchanged.

**Order BOM after Fan Replacement**

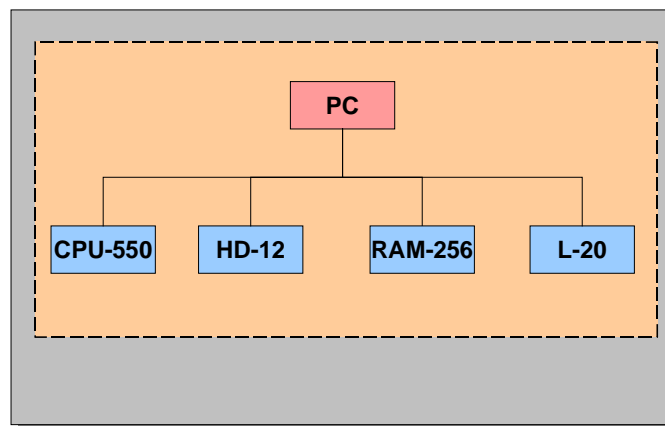

---

**Sales Order Processing for Products with Many Variants (Struct.)**

You can create an order BOM in two different functions:

- [Configuration \[Page 34\]](#)
- [Order browser \[Page 51\]](#)

5. You execute a MRP run.

The system generates planned orders to cover the requirements. The order BOMs are also taken into account.

6. You convert the planned orders into production orders.

The system transfers the order BOMs into the component overview of the production order. The order plans are also automatically taken into account by the system.

At any time during this process you can execute an order BOM cost estimate.

- During the design process it is already possible to execute order BOM cost estimates for individual assemblies.
- When the design for the entire product is completed, you execute a sales order cost estimate for the entire multi-level BOM for a sales order item, in the sales order.



## Sales Order Processing with Engineer-to-Order Production

### Example: Turbine

In this example, the sales order processing for complex products in the engineer-to-order production, such as a turbine, is presented. This is an example of a process, the elements of which are combined with elements from other processes.

### Purpose

As a manufacturer of turbines you produce your products for large, capital-intensive projects. Since you specially tailor each turbine to the requirements of your customers, each sales order involves you spending a great deal of time on design and development.

You can pre-plan one part of your assembly. In your SAP system, you have created material BOMs for all of the assemblies that you produce in either an identical or slightly modified form.

For each sales order, you modify pre-planned assemblies and, when necessary, design new assemblies from scratch. The design takes place in a bottom-up-process, in other words you design assemblies on the lower levels of a multi-level BOM and later insert them into the higher levels.

Design and production take place partly parallel to each other: Some assemblies have a long replenishment lead-time. You start the production of these assemblies at a time when you are still designing other assemblies.

### Prerequisites

#### Master data

You have created a material BOM for your T-20000 turbine, which contains, among other things, the following components:

T-20100	Turbine casing
T-20200	Running gear
T-20300	Generator
T-20400	Control unit (rack)

Some of these components are themselves assemblies.

### Process Flow

In the course of the sales meeting you realize that the T-20000 turbine, for which you have already created a material BOM, is the closest match to the requirements of the customer. However, sales-order-specific modifications are necessary for several assemblies.

Furthermore, the customer requires an extra coolant pump due to the climatic conditions at the usage site. Due to the high density of sand and dust particles at the usage site, the casing of the coolant pump has to be especially protected to avoid the penetration of such particles.

## Sales Order Processing with Engineer-to-Order Production

Until now, you have not produced a coolant pump that matches these criteria. Therefore, you also do not have a material BOM for it. You have to design this coolant pump especially for this customer.

1. You create a sales order.

In the sales order item 10 you enter the material T-20000.

2. You create a project with the number T-22223.

You create a network. You maintain the reference points in the network operations.

3. You want to carry out sales-order-specific modifications to the turbine casing and the running gear. To do this, you fix the corresponding BOM in the order browser.

The system then creates order BOMs as copies of material BOMs. You carry out the necessary changes to these order BOMs so that the product matches the customer requirements. The changes that you make to an order BOM do not affect the material BOM with the same material number.

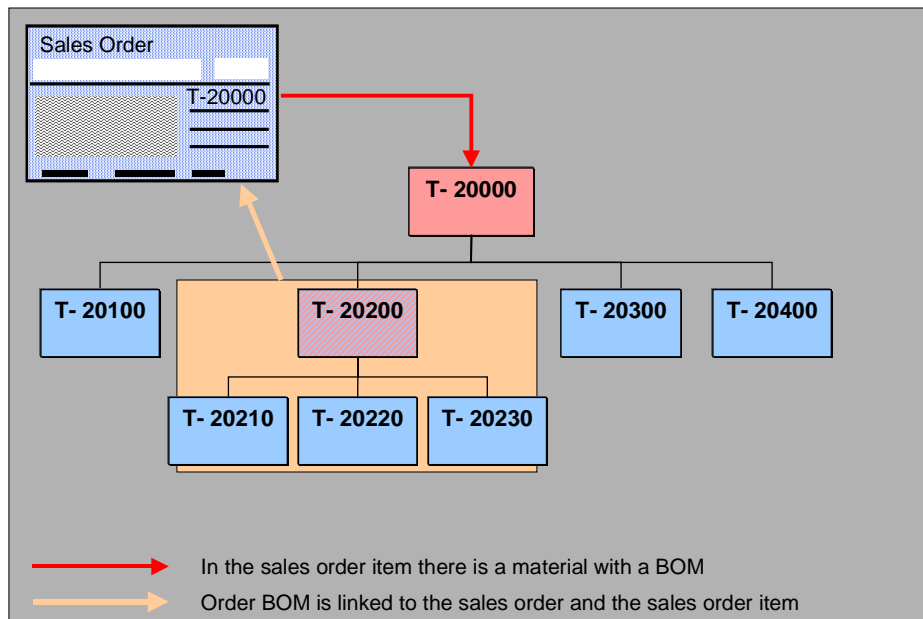

4. You design the extra coolant pump especially for this sales order. You do not yet know at which point you are going to integrate the coolant pump into the multi-level BOM. You create the following data in the SAP system:

- a. You create a new material with the material number P-110 for the coolant pump.
- b. You manually create an order BOM for the material P-110.

You see a [detached order assembly \[Page 23\]](#). The detached order assembly is linked to the sales order item but not, however, to the multi-level BOM.

## Sales Order Processing with Engineer-to-Order Production

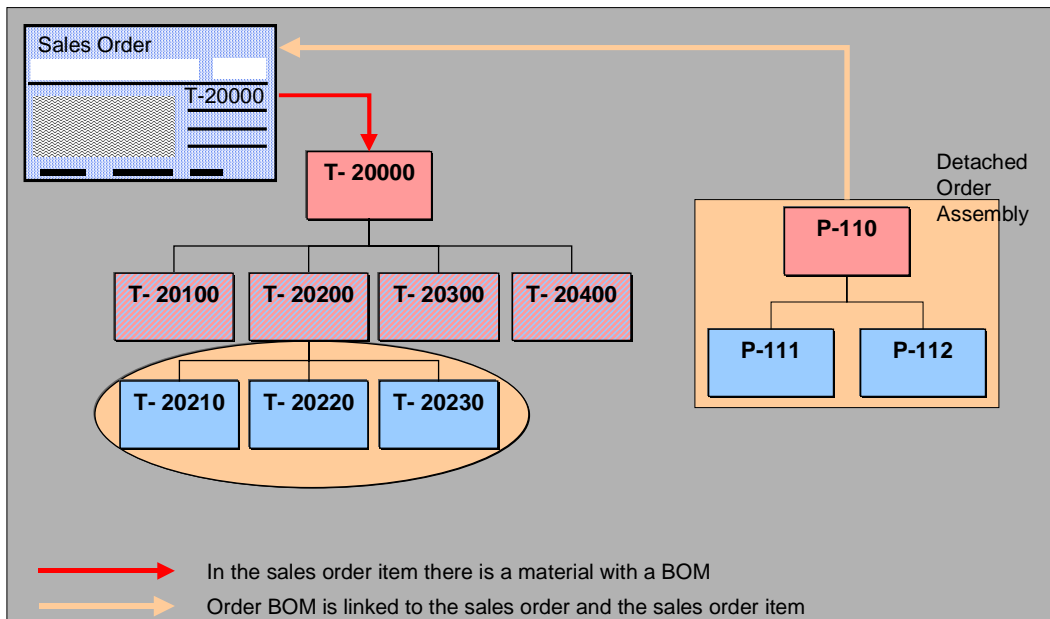

5. Once you have designed the coolant pump P-110, you want to start the production immediately so that it is available on time. Therefore it is not essential that the design for the entire turbine is completed.

**See also:**

[Assemblies with a Long Replenishment Lead Time \[Page 21\]](#)

- a. You create a network operation for the assembly of the coolant pump P-110.
- b. You maintain the reference points in the network operation and in the BOM items.
- c. You transfer the order BOM for the coolant pump P-110 to Project System.

If you trigger a multi-level BOM transfer for the T-20000 turbine, the coolant pump P-110 is **not** transferred with it because it has no relation to the header material for the T-20000 multi-level BOM. Therefore you have to trigger a BOM transfer especially for P-110.

To ensure that the requirements are later correctly allocated in the final BOM transfer, you first generate preliminary requirements.

The system assigns the BOM items to network operations with identical reference points. The components of the coolant pumps P-111 and P-112 are therefore assigned to the network operation 3000.

Sales Order Processing with Engineer-to-Order Production

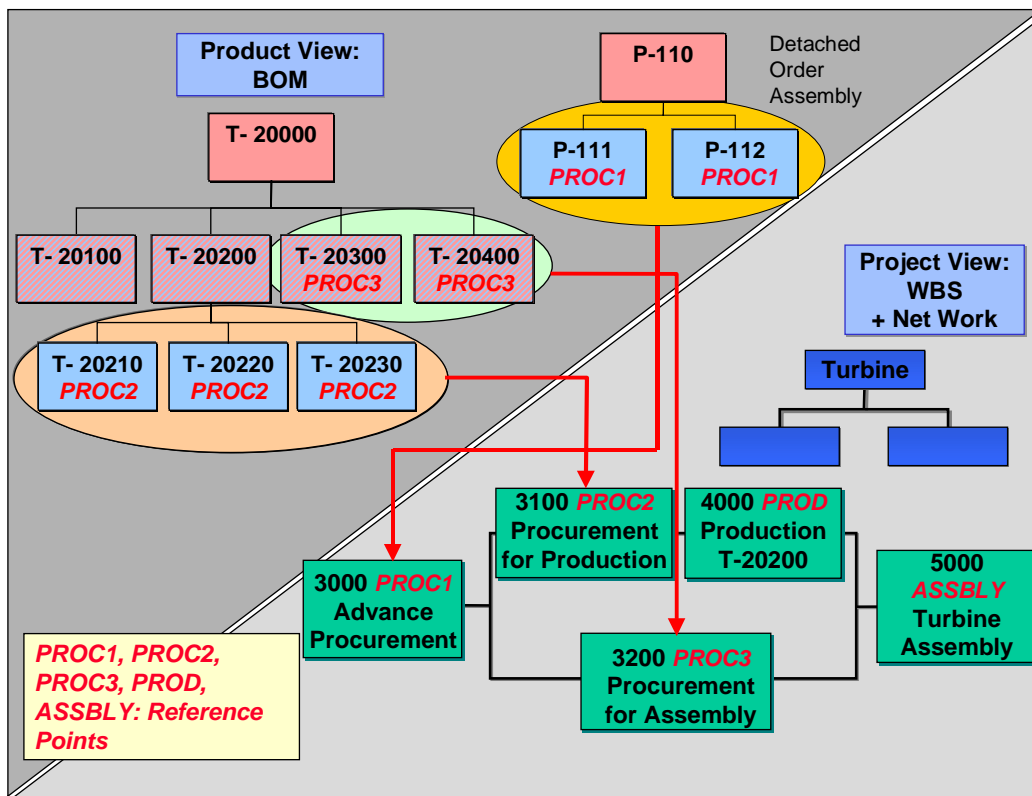

6. Now you want to generate planned orders in MRP for the coolant pump components. To do this, you carry out the following steps:
  - a. You determine that the network operation 3000 (advance procurement) is relevant to requirements.
  - b. You execute a planning run.
 

The system generates planned orders for P-111 and P-112, which you can convert into production orders.
7. At a later date you finish the design for the entire product.
  - a. You include the coolant pump P-110 in the BOM for the T-20000 turbine.
  - b. You determine that all network operations are relevant to requirements.
8. You trigger a BOM transfer for the T-20000 turbine again.
 

The system settles the preliminary requirements generated by the first BOM transfer against the newly generated requirements.

## Assemblies with a Long Replenishment Lead Time

### Purpose

It is often necessary to obtain an assembly with a long replenishment lead-time before the design of the entire product is completed.



In the turbine T-20000 you require an extra coolant pump. You have to start early with the production of the pump so that it is available on time. However, the design of the entire turbine is not yet complete. You can not yet decide at which point you are going to integrate the second pump in the multi-level BOM for the sales order item.

### Process Flow

You have already created the sales order.

1. You create an order BOM for a material that is not yet included in the multi-level BOM for the sales order item.

This type of assembly is referred to as a [Detached order assembly \[Page 23\]](#).

2. You generate preliminary requirements for the detached order assembly.



When you execute a requirements planning run for the material of the sales order item, only the assemblies that exist in the multi-level BOM are included. If a detached order assembly has a long replenishment lead time, it may be necessary to generate requirements even before the design of the entire product is completed

You have the following options:

- You can create a planned independent requirement for an assembly that is not contained in the multi-level BOM for the sales order item. You assign this planned independent requirement to the sales order. The assembly can have either an order BOM or a material BOM.

**See:** [Material Requirements Planning for Detached Order Assemblies \[Page 118\]](#)

- When you work with Project System, you can transfer a detached order assembly to Project System and generate preliminary requirements.

**See:** [BOM Transfer to Project System \[Ext.\]](#)

3. You execute a planning run.

The system generates planned orders, which you can convert into production orders.

4. You continue with designing the whole product.

In the [order analysis \[Page 67\]](#) of the order browser, you have an overview of all detached order assemblies for a sales order item. During the design process you decide at which point to insert the detached order assembly into the multi-level BOM.

5. You include the header material of the detached order assembly as an item in an assembly in the multi-level BOM for the sales order item.

### Assemblies with a Long Replenishment Lead Time

This causes the detached order assembly to become integrated in the multi-level BOM.

**See also:**

[Detached Order Assembly \[Page 23\]](#)

## Detached Order Assembly

### Definition

An assembly whose BOM was created with reference to a sales order, but whose header material however, is not a component in the multi-level BOM for the sales order item. A detached order assembly is assigned to a sales order but has not yet been inserted into the multi-level BOM for the sales order item.

### Structure

A detached order assembly has the same structure as a normal assembly, however, it has the following special features:

- It was created with reference to a sales order item.
- Its header material has not yet been inserted into the multi-level BOM for the sales order item.

This means that a detached order assembly has:

- A reference to the sales order and to the sales order item
- No reference to the multi-level BOM of the material that you entered in the sales order item

#### **Bill of Material with a Detached Order Assembly**

## Detached Order Assembly

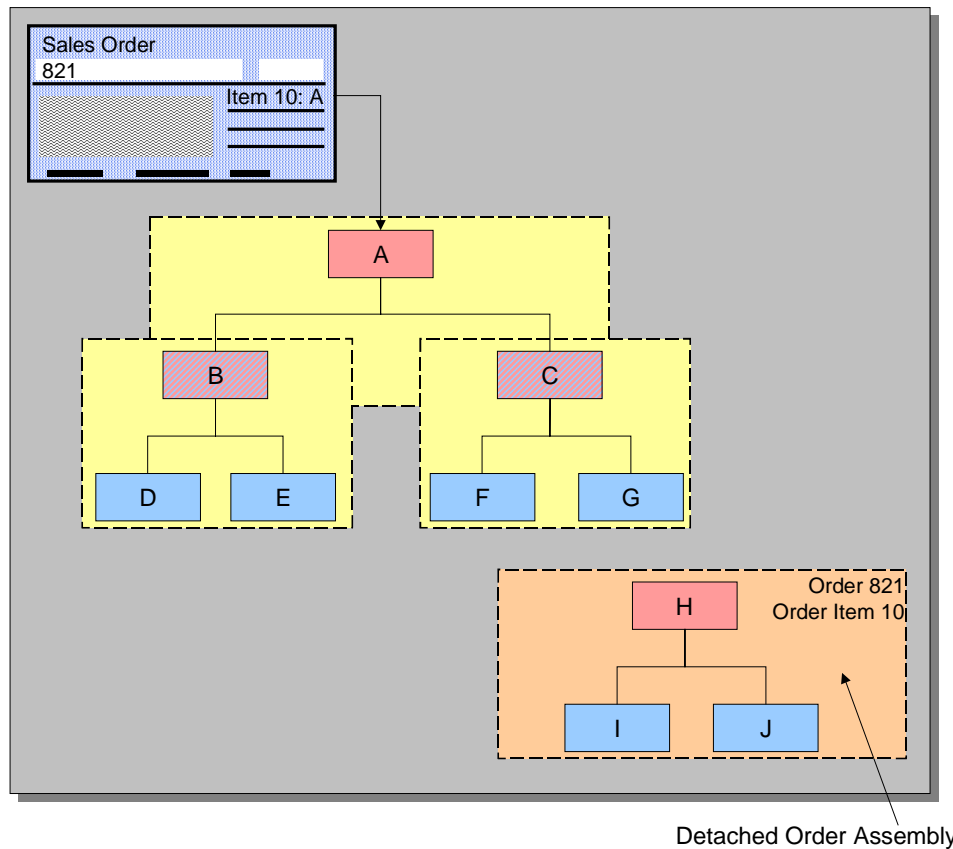

The components of a detached order assembly can themselves also be assemblies.

**See also:**

[Creating a Detached Order Assembly \[Page 28\]](#)

[Inserting a Detached Order Assembly \[Page 29\]](#)

[Example: Detached Order Assembly \[Page 25\]](#)



## Example: Detached Order Assembly

The material BOM for material A contains components B and C, which are themselves assemblies. The material BOM for material C contains components D and E and the material BOM for material C contains components F and G.

### Multi-Level Material BOM

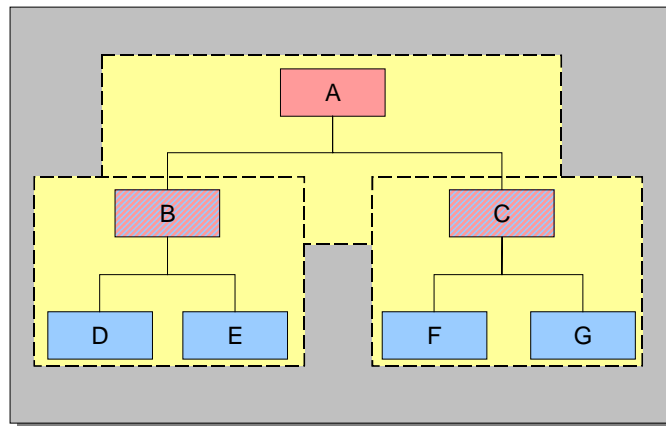

You create a sales order with the number 821 for customer "Jones". You enter material A in item 10 of sales order 821.

For the Jones Company sales order, component H is to be added to the product. You have never produced component H before, which means that you will have to design it first. Therefore you create an assembly with reference to the sales order with material H as the header material. You want to produce assembly H with materials I and J, which means that materials I and J become items in this order assembly.

### Bill of Material with a Detached Order Assembly

## Example: Detached Order Assembly

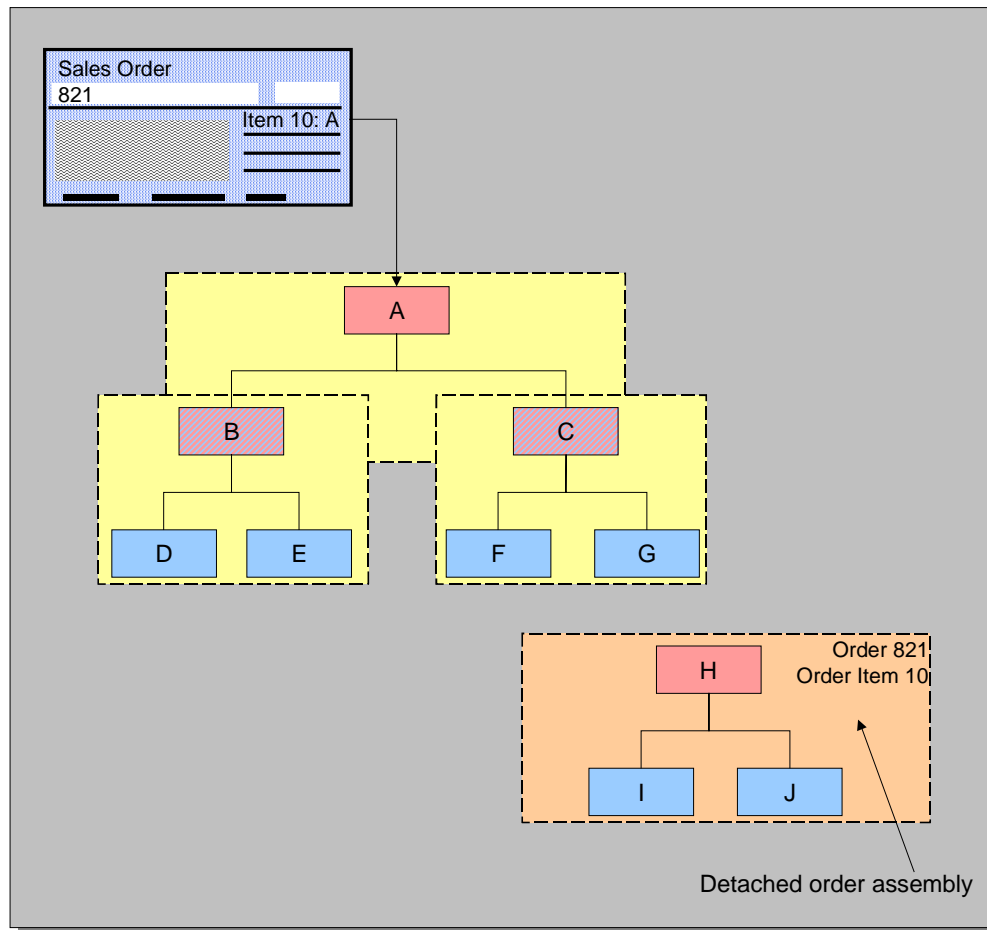

The order assembly for material H now exists, however it is not yet integrated within the multi-level BOM for the sales order item. Material H is to be inserted as a component into the bill of material for material C. You insert material H as an item in assembly C and save this with reference to the sales order.

**Bill of Material with an Integrated Order Assembly**

Example: Detached Order Assembly

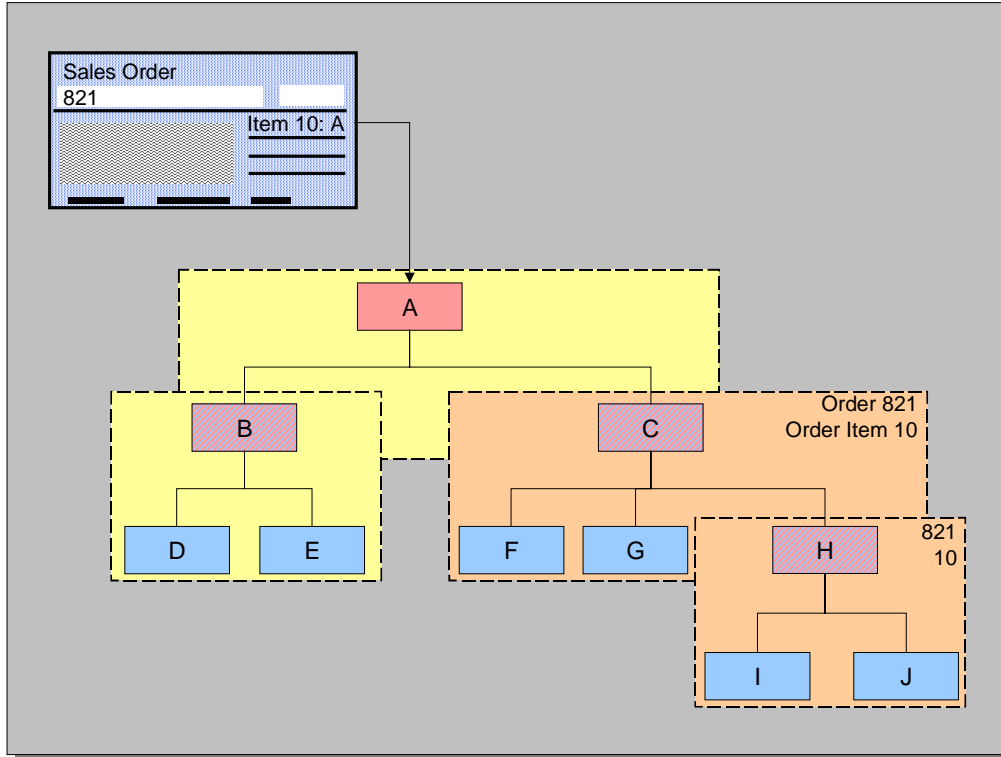

---

**Create Detached Order Assembly**

## Create Detached Order Assembly

### Use

You create a detached order assembly if, for example, you have to design, order or assemble certain components, before the design of the whole product is complete. You do not have to decide until later, at which point you want to insert the detached order assembly.

### Prerequisites

You have already entered the material, into which you later want to insert the detached order assembly, in a sales order.

### Procedure

1. Choose *Logistics* → *Production* → *Master data* → *Bills of material* → *Bill of material* → *Order BOM* → *Create*.
2. Create an order BOM as described in [Creating an Order BOM \[Page 53\]](#).

If the BOM header material that you entered in the initial screen is not available in the multi-level BOM for the sales order item, you see a detached order assembly.

### Result

In the order analysis the detached order assembly is shown on the tab page *Detached*.



A detached assembly is also created if you

- Delete an item in a bill of material, which is the header for an order BOM
- Delete a bill of material, that contains an item which is the header for an order BOM

## Inserting a Detached Order Assembly

To insert a detached order assembly into the multi-level BOM for the sales order item:

You are in the order browser.

1. Check whether the BOM, into which you want to insert the detached order assembly, is an order BOM.

If this is not the case, fix the BOM in the order browser first.

2. In the order browser, right click on the header of the assembly in which you want to insert the detached order assembly, and select *Change*.

The item overview of the order BOM appears.

3. Enter a new item for the material of the detached order BOM and save.

The assembly is inserted in the multi-level BOM for the sales order item. In the order analysis the order assembly is shown on the tab page *Order BOMs*.

---

**Entering a Sales Order**

## Entering a Sales Order

### Prerequisites

If you are working with sales order BOMs for configurable materials, you can define, in the configuration profile for the configurable material, whether characteristic value assignment for lower-level components for the sales order BOM is possible from the sales order.

If you wish to carry out characteristic value assignment for lower-level components in the sales order, you need to select the indicator *Maintenance in order allowed* in the configuration profile for the material. This means it is possible to go from the sales order to maintaining sales order BOMs, via the *Engineering* button, in order to carry out characteristic value assignment for lower-level components here.

It is not possible to process the sales order BOM in the sales order.

### Process Flow

#### Characteristic Value Assignment for Lower-Level Components not Allowed in the Sales Order

1. Enter a sales order and enter the configurable material as an order item (see also [Item Categories for Configurable Materials \[Ext.\]](#)).  
You can find out how to create a sales order by reading the *Sales* document in the section [Create Sales Order \[Ext.\]](#).
2. You will get to the characteristic value assignment screen by assigning characteristic values for the material characteristics. Depending on the characteristic value, the object dependencies are evaluated for the configuration profile, the characteristics and characteristic values.
3. The bill of material is not exploded in the sales order. Lower-level configurable materials cannot be assigned characteristic values in the sales order.
4. The header material is displayed as an order item in the sales order.
5. Once you have saved the sales order, you can process the bill of material for the sales order, using the function *Bill of Material → Order BOM → Maintain (Multi-Level)* in the bill of material menu. As a result, the assignment of characteristic values for the material from the sales order can only be displayed, and not changed.

#### Characteristic Value Assignment for Lower-Level Components Allowed in Sales Order

1. Enter a sales order and enter the configurable material as an order item (see also [Item Categories for Configurable Materials \[Ext.\]](#)).  
You can find out how to create a sales order by reading the *Sales* document in the section [Create Sales Order \[Ext.\]](#).
2. You will get to the characteristic value assignment screen by assigning characteristic values for the material characteristics. Depending on the characteristic value, the object dependencies are evaluated for the configuration profile, the characteristics and characteristic values.
3. Choose the *Engineering* button, in order to process the bill of material.
  - characteristic value assignment from the sales document is not displayed

## Entering a Sales Order

- you can assign characteristic values for the lower-level configurable materials.
- you can change the bill of material specifically to the sales order.

## 4. Save your changes.

The bill of material is stored outcome-oriented.

5. Choose the *Sales* button, in order to get back to the sales order.

Changes, which you make when valuating the material, can have effects on the order BOM.

## 6. The header material appears as an order item in the sales order.

---

**Blocking Requirements**

## Blocking Requirements

### Use

You can block the generation of requirements until the processing of order BOMs is completed. In this way, you can prevent the system from generating requirements during the planning run, for assemblies that are still to be post-processed in the design.

### Features

You can stop the generation of requirements on different levels:

- in the **schedule line category** in the sales order item

A requirement generation is stopped by some schedule line categories, for example, in the standard system, by the schedule line category CN. At the time when you want to generate requirements, set the schedule line category CP for example. This schedule line category allows the generation of requirements in the standard system.

In Customizing SD you define, for specific combinations of item categories and MRP types:

- Which schedule line category the system recommends as standard.
- Which schedule line categories can be set manually.

In Customizing SD choose *Sales* → *Sales document* → *Schedule lines* → *Assign schedule line categories*.

- for configurable BOMs, you can stop it in the **configuration status** in variant configuration

**See also:**

[Transfer of requirements using blocked configuration \[Ext.\]](#)

- In the **BOM status**

You define the status of a BOM in Customizing BOMs, by choosing *General Data* → [Define BOM status \[Ext.\]](#).

You set the status of a BOM in the detail screen of the [BOM header \[Ext.\]](#).



## Creating an Order BOM

### Purpose

You create an order BOM if you work in make-to-order production and want to respond to special customer wishes, or if you are manufacturing a product, which you have never before produced in that form. You want to change one or more assemblies specific to a particular order, without having to change the material BOM.

### Process Flow

When you create an order BOM, there are two different possible process flows. Which of the two processes is relevant to you depends on whether or not you work with variant configuration.

- If you work **without** variant configuration, create an order BOM for a BOM to which you want to make order specific changes. Then, change the order BOMs according to customer requirements. You call up all the functions of the **order browser**. For more information, see [Creating Order BOMs Without Variant Configuration \[Page 52\]](#)
- If you **do** work with variant configuration, assign values to the characteristics for the material in the sales order item, or the configurable assemblies. If necessary, also make manual changes to the configurable assemblies. When you save the configuration, the system can generate order BOMs. For more information, see [Creating Result-Oriented Order BOM \[Page 41\]](#) If you need to, also create order BOMs for non-configurable materials (similarly to the process without variant configuration) using the *order browser*.



Material BOMs and order BOMs exist in the system independently of each other. When you create an order BOM and afterwards, make changes to the material BOM with the same material number, then the changes do not take effect in the subsequent processes (for example, planned orders, production orders, purchase requisitions and so on). However, material BOMs and order BOMs are merged in the variant configuration. At the same time, changes you made to the material BOM then take effect in the order BOM. You can find further information in [Merging with Global Material BOMs \[Page 49\]](#)

## Order BOMs for Variant Configuration

### Purpose

Products that are made to order in plant engineering and construction and mechanical engineering are generally very complex and are specific to one customer. For this reason, you cannot define a BOM entirely in advance. Once you have created your sales order, you need to make manual changes to the BOM by creating an order BOM especially for the sales order, without changing the original BOM.

An order BOM is identified by the sales order, sales order item, and material number.

In variant configuration, you can work with 2 types of order BOM. The difference is in the way they are saved:

- [Knowledge-Based Order BOM \[Page 39\]](#)

The order BOM is saved as a copy of the super BOM with manual changes and dependencies.

- [Result-Oriented Order BOM \[Page 41\]](#)

The configuration result is saved as an order BOM, with manual changes but without dependencies.

### Process Flow

1. You create a sales order for a material (see [Creating Sales Orders \[Ext.\]](#)). The material is configured in the sales order. You cannot configure the configurable assemblies of the BOM in the sales order. The explosion of your structure is not displayed if the *Engineering* view is selected in the configuration profile.



You can also create an order BOM for a quotation. However, you cannot copy the order BOM for a quotation to a sales order.

2. Once you have entered the sales order, you can use the maintenance function *Bill of Material* → *Order BOM* → *Maintain (Multi-Level)* to process the BOM. The order BOM maintenance function explodes the entire structure of the order BOM. You can configure the configurable assemblies.

The engineering process determines which assemblies need to be changed and which new assemblies are required.

You can make the following changes to a BOM:

- Change BOM items (for example, quantity)
- Add items

When you add an item, change the item number. The default is always the number of the item you selected. However, each item number should only occur once in a BOM.

- Delete items
- Copy items

---

**Order BOMs for Variant Configuration**

- Cut items
- Specify class items manually

Creating the order BOM is known as fixing. Order BOMs are created individually for each assembly. If you fix the BOM of the header material, you do not necessarily fix the BOMs of subordinate configurable assemblies (exception: *Top-down* setting).

3. Once you have finished processing the BOM structure, you can start to release assemblies for MRP.

## Result

You create an order BOM by fixing the BOM of a material. The BOM is fixed if one of the following applies:

- Manual changes are made to assemblies
- The configuration profile for the assembly has the *Automatic fixing* indicator or you choose *Fix* on the result screen of the maintenance function

### Restrictions in BOM Maintenance

- BOMs of non-configurable assemblies are not exploded.
- In a knowledge-based order BOM, you can only process configurable assemblies that have the *Order BOM* setting in their configuration profile. In a result-oriented order BOM, you can maintain all assemblies.
- Characteristic values can only be assigned to configurable assemblies that have the *Order BOM* setting.
- If you use engineering change management, you cannot use the change overview to display change information, because the order BOM is a new BOM – not a new version of the original BOM.

### See also:

[Process: Order BOM \[Ext.\]](#)

[Settings in the Configuration Profile \[Page 38\]](#)

## Example: Order BOMs in Variant Configuration

## Example: Order BOMs in Variant Configuration

The material BOM of material A contains components B and C, which are assemblies. The material BOM of material B contains components D and E. Component D has 2 variants that have dependencies. According to the values assigned in the sales order, only one of these variants is used. Similarly, component E has 3 variants. The following graphic shows this BOM as a multi-level super BOM with all variants.

Multi-Level Super BOM

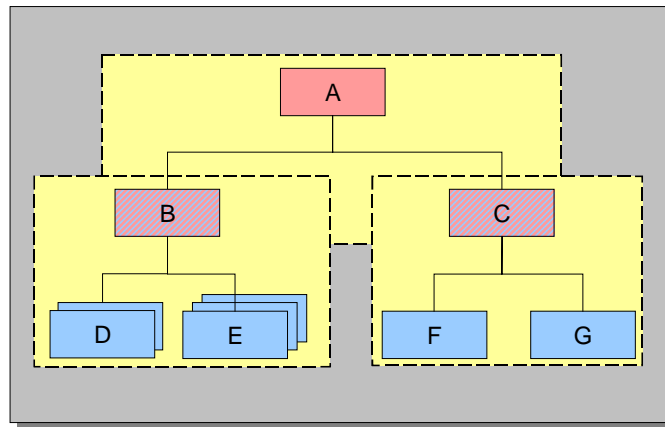

Once you have assigned values to the characteristics of material B, it transpires that the second variant of component D and the first variant of component E are selected. (The components that are not used are shown in black in the following graphic.)

Multi-Level Super BOM After Characteristic Value Assignment and Before Fixing

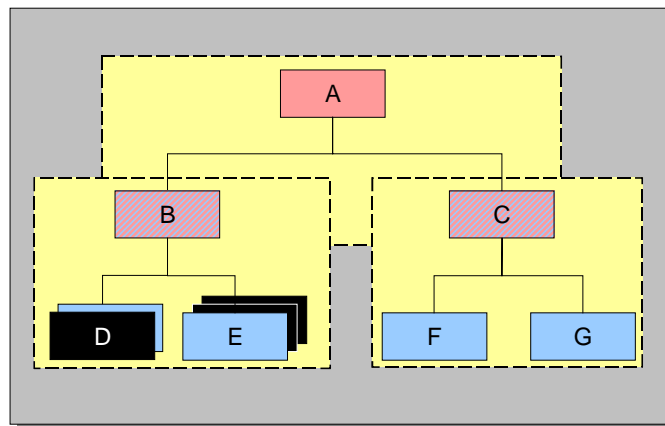

You fix the assembly. When you save the configuration result, the system generates an order BOM for material B. If *Result-oriented BOM* is set in the configuration profile of the configurable material, the system only creates the components that are used in the order BOM (see [Creating a Result-Oriented BOM \[Page 41\]](#)). If this indicator is not set, the system creates an order BOM that contains all components of the super BOM and the local dependencies as a copy, referencing all other data (see [Creating a Knowledge-Based BOM \[Page 39\]](#)).

Example: Order BOMs in Variant Configuration

Order BOM After Fixing – Result-Oriented BOM

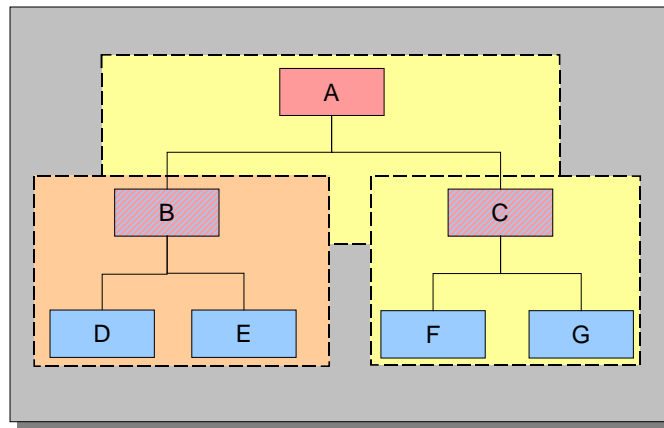

## Settings in the Configuration Profile

## Settings in the Configuration Profile

### Use

In the configuration profile of a material, you can define various settings for processing order BOMs.

- You can use the *Result-oriented* indicator to specify that the result of an order BOM is saved as shown on the result screen in the configuration editor. See [Creating a Result-Oriented Order BOM \[Page 41\]](#)

If this indicator is not set, the super BOM is saved with manual changes and dependencies, not the configured BOM. See [Creating a Knowledge-Based Order BOM \[Page 39\]](#)

- You can allow value assignment for subordinate components of the order BOM in the sales order.

To do this, the indicator *Maint. in order allowed* must be set in the configuration profile. You can then use the *Engineering* pushbutton in the sales order to go to order BOM maintenance, and assign characteristic values to subordinate components there.



You cannot process the BOM in the sales order.

- You can select the *Automatic fixing* indicator to specify that order BOMs are always saved for a configurable material, even if no manual changes are made. This function becomes active when you start the maintenance transaction for order BOMs. (in the BOM menu: *Order BOM* → *Maintain Multi-Level*).

If you do not select *Automatic fixing*, no order BOM is saved for the material until manual changes are made or you choose the *Fix* pushbutton.

The settings for [fixing \[Page 46\]](#) are also read. If you select, for example, the *Top-down* setting (the proposed values are *Selected assys*, *Bottom-up*, and *Top-down*), and *Automatic fixing* in the configuration profile for a material, the entire structure is saved as an order BOM when you save the order BOM.

- To enter default values for processing the order BOM, choose *Fix* or *Fix/instantiate*. You can change these settings when you process the order BOM.

You can only define settings for [instantiation \[Page 43\]](#) if you select *Result-oriented* first.

#### See also:

[Process: Order BOM \[Ext.\]](#)

## Creating a Knowledge-Based Order BOM

### Use

When you create a knowledge-based order BOM, you copy the super BOM and you copy its local dependencies with manual changes. All other data is referenced. You save the entire BOM structure with all non-variable parts and variant parts, not the result of the BOM explosion. Every time you call the configuration editor, and in subsequent processes (such as material requirements planning), the order BOM is re-exploded according to the assigned characteristic values, and the dependencies are re-processed.

Changes to global dependencies and classification take effect each time the order BOM is reopened.



You **cannot** create knowledge-based order BOMs in the [Order Browser \[Page 51\]](#).

### Prerequisites

You have created a material BOM for the material for which you want to create an order BOM. The material BOM is a super BOM, containing all the components that could be used in the finished product.

### Configuration Profile

In the [configuration profile \[Ext.\]](#) of the material in the sales order item, and all configurable assemblies that you want to save as order BOMs, the BOM explosion setting must be either *Single level* or *Multi level* and the *Order BOM* indicator must be selected.

### Relevance to Material Requirements Planning (MRP)

To ensure that order BOMs are relevant to MRP, set the *Order BOM* indicator in Customizing for *Material Requirements Planning*, by choosing *Planning → BOM Explosion/Routing Determination → Define BOM explosion control*.

### Features

1. You create a sales order and enter the configurable material as an order item.
2. In the sales order, you assign values to all sales-relevant characteristics of the top-level material (single-level configuration).
3. In the BOM menu, you technically post-process the BOM by choosing *Order BOM → Maintain multi-level* from the order BOM menu, assigning values to characteristics of subordinate assemblies (multi-level configuration). You can change one or more configurable assemblies manually on the result screen of the configuration editor.



If you insert a new item, the system checks whether it can use an order BOM that exists for the component. If there is no order BOM, the material BOM is used.

4. Save the configuration result.



---

**Creating a Knowledge-Based Order BOM**

The first level of the configuration is often done by the sales department, whereas the configuration on subordinate levels is done in engineering, for example. However, the configuration on subordinate levels may also be done when the sales order is created.

**Restrictions**

You cannot use the global reporting functions for BOMs, such as BOM comparison, here.

**See also:**

[Processing Sequence for Dependencies \[Ext.\]](#)



## Creating a Result-Oriented Order BOM

### Use

The result-oriented order BOM means that the configuration result with manual changes is saved as an order BOM. Dependencies are not saved. This means that the saved assemblies are smaller than if you saved a copy of the super BOM.

Exploding the BOM in interactive configuration triggers an update using the material BOM. Dependencies are processed, which means that changes to characteristic values can result in a change to the structure. New items that are created in the material BOM are copied to the result-oriented order BOM.

### Prerequisites

On the *Configuration parameters* tab in the configuration profile, the settings *Order BOM* and *Result-oriented* are selected.

### System Performance

Exploding the BOM in non-interactive configuration ([Low-Level Configuration \[Ext.\]](#)) does not process the dependencies again, so this way of saving improves system performance in subsequent processes for configurable materials, such as material requirements planning (MRP).

### Features

The procedure for creating a result-oriented order BOM is the same as for [Creating a Knowledge-Based Order BOM \[Page 39\]](#).

The result-oriented order BOM has the following additional functions:

- Instantiation  
If you change or configure assemblies when processing the order BOM, you can create new material master records without leaving the processing function.
- Creating an order BOM without inclusion in the structure as a whole  
You can use this function to create order BOMs before you know how they will be linked into the structure as a whole.

### Restrictions and Notes on BOM Maintenance

- BOMs of non-configurable assemblies are not exploded on the result screen, unless the *Only configurable assemblies* indicator is deselected in the configuration profile.
- Characteristic values can only be assigned to configurable assemblies that have the *Order BOM* setting.



If you insert a new item on the result screen, the system checks whether it can use an order BOM that exists for the component. If there is no order BOM, the material BOM is used.

## Creating a Result-Oriented Order BOM

### Activities

From the bills of material menu, choose *Bills of Material* → *Order BOM* → *Maintain (Multi-Level)*.

## Instantiating Configurable Materials

### Use

A make-to-order product is identified in logistics processes by the sales order, order item, and material. However, if a configurable material is configured in several different ways in one configuration structure, logistics processes cannot always tell the difference.

To distinguish different configurable assemblies in a BOM that have the same material number, the order BOM maintenance function supports instantiation.



Instantiation means creating a new instance, by creating a material variant – a new material master – for the configurable material. This material master and the characteristic values assigned to it are linked to the super BOM or order-specific BOM.

You cannot instantiate materials that are not configurable.

### Prerequisites

#### Settings in the Configuration Profile and on the Result Screen

If you define the setting in the profile of the top-level configurable material, it is a default value. In other words, the root profile determines the default starting point for the result screen. The setting then has the same effect on all instances.

If you define the setting dynamically on the result screen, it also effects all instances. For example, if you want to instantiate instance 7, the current global setting applies (for example, selected assemblies).

### Features

You can interactively influence the instantiation transaction.

- Number assignment  
The material number can be assigned manually or internally.
- Default data  
The data for the new material for each instance can come from either the original material or another material that you select.
- Data maintenance  
You can specify the industry sector, material type, and material description in a special user interface for maintenance.

#### Instantiation Options

There are 3 types of instantiation:

- Selected assemblies:  
The assemblies you select are instantiated.
- Top down:  
The assembly you select and the entire structure below it are instantiated.

## Instantiating Configurable Materials

- Bottom up:

The assembly you select and all the assemblies in a direct path above it are instantiated.

You define the scope of instantiation in the configuration profile.

The header material cannot be instantiated, even though it is possible to select it if you are using the top-down setting.

**See:** [Fixing Configurable Assemblies \[Page 46\]](#). The 3 types are illustrated here.

### Variant Matching

To ensure that instantiation does not produce a deluge of new material master records, and that one material number identifies one product, you can trigger type matching for variants before you instantiate a material, to find out whether material variants already exist with the same values. These material variants are proposed for you to copy.

### Check for Identical Assemblies

The new material master created by instantiation is not generated until you save. On the configuration structure screen and in the configuration browser, selection for instantiation is shown as an icon.

When you save the instantiation, the system checks for identical assemblies. If the system finds the same assembly with the same assigned values occurring more than once, it merges them to form one material variant. However, this is only possible for materials that are **selected for instantiation**.

## Activities

### Instantiating an Order BOM

1. From the bills of material menu, choose *Order BOM* → *Maintain (Multi-Level)*, and go to the result screen.
2. Select the assembly that you want to instantiate.
3. Choose *Instantiate*.
4. You see a dialog box in which you enter the material number, the industry sector, and the material type. You can also enter a description and a template material for default data.
5. Confirm.

The material is now selected for instantiation. The new material master created by instantiation is not generated until you save. On the configuration structure screen and in the configuration browser, selection for instantiation is shown as an icon.

### Undoing Instantiation to Reassign Values

1. On the result screen, select the header of the instantiated assembly or the assembly that is selected for instantiation, and choose *Delete*.
2. The configurable material (KMAT) is now in its original position, and values can be assigned or changed.

---

## Instantiating Configurable Materials

### Conflict with Instantiated Materials

**Example:** Material BIKE1 occurs multiple times in the BOM structure and was instantiated several times to BIKE2. You want to change one of the material variants BIKE2 by inserting a new material, such as a luggage rack, in the BOM. To avoid a conflict, you must instantiate BIKE2 to BIKE3.

### Material Variant and Template Material

The configurable material (KMAT) is instantiated to a *material variant*. Characteristic values can no longer be assigned or changed, because the material variant is a stock material. This is not the case with a KMAT.

Material variants are not configurable. A frequently occurring error is that the material master is not complete, because the material type of the KMAT and the material type of the *material variant* are different, and the material master record of the KMAT does not contain all the data required (for example, in the storage view).

Solution: Use a template material. The template material is maintained in the same way as a material variant. All SD fields that are not dependent on the distribution channel are copied.

You enter the template material in the instantiation dialog box.

### Result of the Instantiated Material

If you maintain an instantiated material in an order BOM, you automatically change the global material BOM of the material variant. If the material variant is used in other sales orders, the changes are shown.

In the menu of the material master, you can call the new material. The MRP data shows the assignment to the configurable material. If you choose *Variant*, you see the characteristic values that are copied from the configuration of the order BOM. You can maintain further data in the material master record of the material variant.

#### See also:

[Material Exchange in the Order Browser \[Page 69\]](#)

[Material Exchange \[Page 183\]](#)

---

**Fixing Configurable Assemblies**

## Fixing Configurable Assemblies

### Use

Fixing creates the actual order BOM. In other words, it creates an order-specific copy of an assembly. If an assembly is not fixed, the sales order refers to the super BOM.

You can fix assemblies by defining settings in the configuration profile or by interactively making manual changes when maintaining the BOM structure.

### Prerequisites

#### Settings in the Configuration Profile and on the Result Screen

If you define the setting in the profile of the top-level configurable material, it is a default value. In other words, the root profile determines the default starting point for the result screen. The setting then has the same effect on all instances.

If you define the setting dynamically on the result screen, it also effects all instances. For example, if you want to fix instance 7, the current global setting applies (for example, selected assemblies).

### Features

Depending on the type of fixing you select, all assemblies in the explosion can be fixed.

You can define the scope of order BOMs that are created.

- Selected assemblies:  
The assemblies you select are fixed.

Selected Assemblies

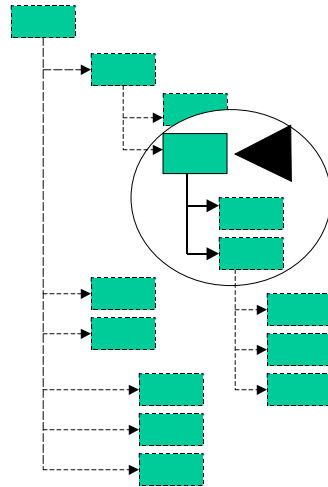

- Top down:  
The assembly you select and the entire structure below it are copied, and can then be processed for a specific order.

Top-Down

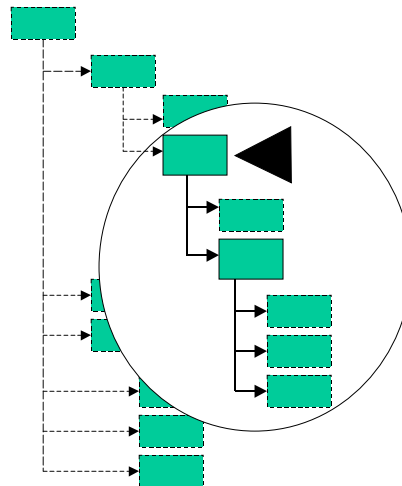

- Bottom up:

## Fixing Configurable Assemblies

Order BOMs are created for the assembly you select and all the assemblies in a direct path above it.

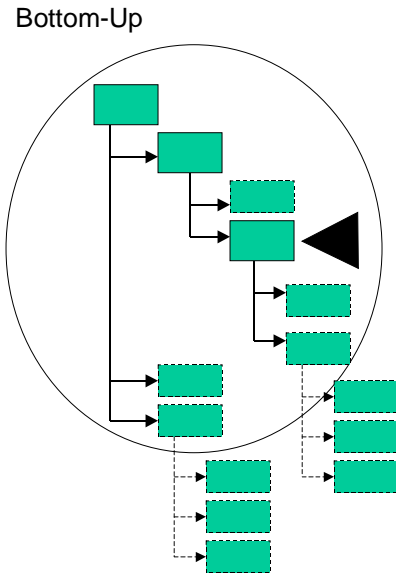

## Activities

You fix assemblies on the result screen of the BOM explosion. From the bills of material menu, choose *Order BOM* → *Maintain (Multi-Level)*.

- To define the scope of assemblies you want to fix, choose *Extras* → *Settings* → *Order BOM* then *Fix*.
- To fix assemblies according to the predefined settings, choose *Fix* or change the BOM.

In the structure in the configurator, you see an icon against the assemblies you fixed. Save the order BOM and open it again, and you see the icon in the configuration structure that shows that an order BOM exists.



## Merging with Global Material BOMs

### Consequence of Fixing for Configurable Assemblies

If you fix an order BOM that is processed with variant configuration (CU51), the order BOM can still be re-read and re-displayed. When you load the structure with this function, the changed order BOM is merged with the structure that already exists for the order. Changes affect all configurable assemblies in the structure, whether or not they have been opened in this step. When you save, this merged structure is written to the database.



If you have fixed non-configurable assemblies, they are not merged with global material BOMs (which may have been changed in the meantime).

### Order BOMs and manual changes are merged according to the following rules:

- Any item that was changed in the order BOM (change to any data field) is not changed by the merge. Manual processing overrides the merge.
- Any item that was deleted in the order BOM remains deleted in the merge.
- Any item that was added to the order BOM remains in the order BOM after the merge.
- Any item that was added to the material BOM is in the order BOM after the merge.
- Any item that was deleted from the material BOM is also deleted from the order BOM by the merge, unless it was changed manually beforehand.
- Any item that was changed in the material BOM is copied to the order BOM after the merge, unless it was changed manually in the order BOM beforehand.

### How can I prevent a merge?

If you want to prevent merging of order BOMs for configurable assemblies when using *Order BOM* functions, you must write a user exit that defines the circumstances under which the order BOM is not updated to match the model. (This requires a field entry in the header of the BOM for which you want to prevent an update to match the model.)

### Processing order BOMs with Variant Configuration (CU51)

You can use variant configuration functions to process order BOMs for non-configurable materials in the same way and with the same result as if you were using the function without variant configuration (CS62).

You only need to process configurable assemblies in the transaction for order BOMs with variant configuration if you have suppressed merges with global BOMs, or if you want to use merges with the effects of changed characteristic values.

If you want to be able to use the options for reassigning characteristic values (with or without merges), do all of your order BOM processing in this transaction.

If you assign new values to characteristics in an order BOM that has been changed manually, the new configuration result is merged with the manual changes according to the rules described above, then with the global order BOM, unless you have used a user exit to suppress this.

---

**Merging with Global Material BOMs**

If you only use result-oriented order BOMs, and only use configuration to generate an initial result that is then subject to extensive manual changes, it is best to use CSAB with order BOMs without configuration (CS1/62).

**See also:**

Merging order BOMs without variant configuration:

[Creating an Order BOM \[Page 33\]](#)

[Create an Order BOM \[Page 53\]](#)

[Fixing a BOM in the Order Browser \[Page 71\]](#)

## Order Browser

### Definition

Navigation tool used to display the multi-level BOM of a material entered in a sales order item.

### Use

You use the order browser when you, as a make-to-order manufacturer, work with order BOMs. After you have created a sales order and, if required, executed variant configuration, it is necessary to technically post-process the BOMs. The changes that you carry out during this process are only valid for this sales order.

In a central screen you get an overview of the current processing status of a multi-level BOM for a sales order item and you can navigate to the process and evaluation functions for order BOMs.

### Structure

In the order browser, the multi-level BOM is displayed similarly to in the [product structure browser \[Ext.\]](#). This means you see an overview tree, whose branches you can show and hide. As opposed to the product structure browser, in the overview tree of the order browser, only the BOM headers and items are displayed.

In the overview tree, the whole multi-level BOM for a sales order item is displayed. If an assembly was not saved as order-specific, the material BOM is displayed at the appropriate point.

In the order browser you process both configurable and non-configurable order BOMs. However, configurable order BOMs are only displayed if you have selected *result-orientated* in the configuration profile.



[Detached order assemblies \[Page 23\]](#) are **not** displayed in the overview tree. You can see an overview of the detached order assemblies for a sales order item in [order analysis \[Page 67\]](#).

---

**Creating Order BOMs without Configuration**

## Creating Order BOMs without Configuration

### Use

In order to adjust your product to the requirements of the customer you want to change a non-configurable assembly with reference to a specific order.

### Features

If you want to create an order BOM for a non-configurable material you have the following options:

- Fixing the BOM in the Order Browser
  - The system generates an order specific copy of the material BOM in which you can make the necessary changes.
  - See also:**  
[Fixing a BOM in the Order Browser \[Page 71\]](#)
- You create an order BOM manually
  - You use this function primarily if you want to create an order BOM for a material that does not yet exist in the multi-level BOM for the sales order item. In this case you get a detached order assembly.
  - See also:**  
[Create an Order BOM \[Page 53\]](#)  
[Detached Order Assembly \[Page 23\]](#)
- You execute a material replacement in the order browser.
  - You use this function in certain circumstances, for example when an assembly in the multi-level BOM is used in different nodes and you want to make various changes to the different nodes. When you execute a material replacement, the system creates a new material master record.
  - See also:**  
[Material Replacement \[Page 69\]](#)

## Create an Order BOM

### Prerequisites

You have entered the sales order for which you want to create the order BOM.

### Procedure



1. Choose *Logistics* → *Production* → *Master data* → *Bills of material* → *Bill of material* → *Order BOM* → *Create*.

The *Create Order BOM: initial screen* appears.

2. Enter the sales order number, the order item, the material number and the BOM usage.
3. If you want to use a material BOM, or an existing order BOM to copy from, go to step 4. If you want to create an order BOM without a reference, click  and go to step 7.



You cannot use a configurable BOM as a reference.

4. Click  *Order BOM* (copy order BOM) or  *Material BOM* (copy material BOM).

The *Copy material BOM* or *Copy order BOM* dialog box appears.

5. Enter the data required and click .

The item overview appears, for the bill of material you are using as a reference.

6. Select the items you want to copy to the order BOM and click .

The item overview for your new order BOM appears. The items you transferred are displayed in the item overview.

7. Enter new items and alter items if necessary. Entering items in order BOMs is similar to entering items in material BOMs. However, you cannot enter class items in order BOMs. You can find further information in the *Bills of Material* documentation in [Creating New Items \[Ext.\]](#).
8. Save your order BOM.

### Result

The system creates an order BOM.

You can find further information on the special features of order BOMs compared with material BOMs in [Editing an Order BOM \[Page 79\]](#).

### Order BOMs for Configurable Materials

If you use this function to create an order BOM for a configurable material, you will always see a **result-orientated** order BOM.

If you call up the variant configuration at a later date, do not forget that the order BOM is merged with a material BOM that has the same material number. The order BOM is then only merged with the material BOM when the following conditions are met:

**Create an Order BOM**

- The assembly is configurable.
- A valid material BOM with the same material number is available.

You can stop the merge operation with the help of a customer enhancement.

You can find further information about merging in [Merging with Global Material BOMs \[Page 49\]](#)

Example: Creating Without Variant Configuration

### Example: Creating Without Variant Configuration

The material BOM for material A contains components B and C, which are themselves assemblies. The material BOM for material C contains components D and E and the material BOM for material C contains components F and G.

Multi-Level BOM for the Sales Order Item

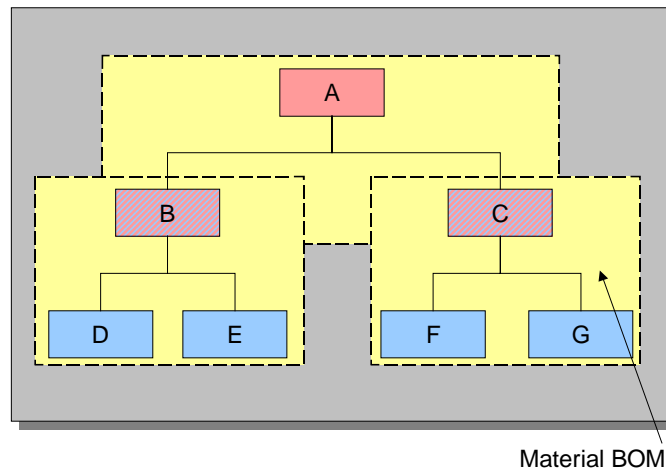

A sales order is created for customer Smith, with the number 821. Material A is inserted under sales order item 10 in this sales order. At the request of customer Smith, for this sales order, the bill of material for assembly C is changed manually. Component H is added to components F and G. This change should not take effect in the material BOM, because assembly C is only expected to be produced once in this form, for customer Smith.

An order BOM is generated from the material BOM for material C. Since nothing was changed in the bills of material for materials A and B, in this sales order the material BOM will continue to be used for these assemblies.

Multi-Level BOM with an Order BOM

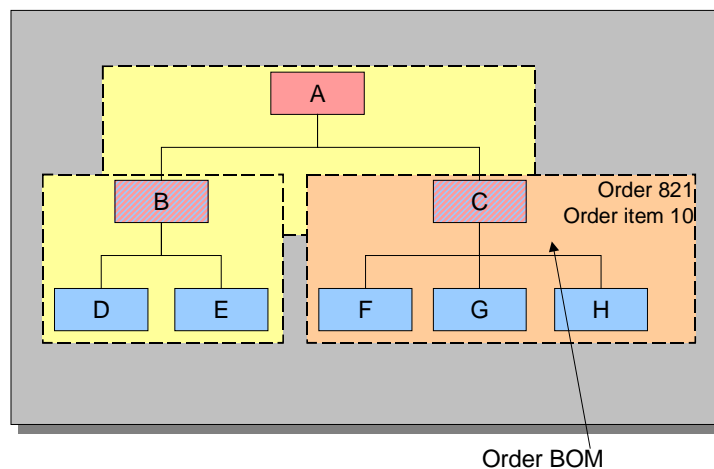

**Example: Creating Without Variant Configuration**



## Working with the Order Browser and Order Analysis

### Purpose

You work with the order browser if you want to clearly display the multi-level BOM for a sales order item, on a central screen. From the order browser you can navigate to the editing and reporting functions for order BOMs and, if necessary, variant configuration.

### Prerequisites

You have created a sales order and entered a material in a sales order item.

If you work with variant configuration, you have set the *Order BOM* indicator and selected *result-oriented* in the configuration profile for the configurable materials. When you entered the sales order, you assigned values to the class characteristics that are assigned to the material in the sales order item.

### Process Flow

The process flow when editing an order BOM with the order browser can be as follows:

1. Enter the required data on the initial screen. You can find further information in [Call up the Order Browser and Order Analysis \[Page 176\]](#)

If you work with [Variant Configuration \[Ext.\]](#), the result of the BOM explosion depends on whether you have completely assigned values to the characteristics and whether you have fixed the bill of material.

Configurable assemblies are displayed in the order browser as follows:

In variant configuration, if you have...	Then the system displays ...
Changed or manually fixed a configurable assembly	The order BOM
Assigned values completely to a configurable assembly, but have not fixed it	The material BOM components resulting from the assignment of <a href="#">Characteristic Values [Ext.]</a>
Have not assigned values to a configurable assembly	Only the non-variable parts, in other words, those components, which do not have <a href="#">Object Dependencies [Ext.]</a>

2. You call up **order analysis** and have an overview of all the assemblies in the multi-level BOM for the sales order item. You see, for instance:

- Which assemblies have been saved as order-specific
- With which assemblies the material BOM is still being used
- Which order assemblies are not yet integrated in the multi-level BOM (detached order assemblies)

These assemblies are only displayed in the order analysis and not in the order browser.

- Which assemblies are used more than once in the multi-level BOM.

If you need to, you can switch back to the order analysis between the following steps, to look at the current status.

### Working with the Order Browser and Order Analysis

3. You call up the **order browser**. In the overview tree you display the branches you are interested in.
4. You go directly to variant configuration, to assign values to the class characteristics for the subordinate configurable assemblies.



We recommend you specify a time when the configuration is complete. Only then should you start processing the order BOMs. If you call up variant configuration again after this time, and then save your data, you should remember that this causes the material BOMs to be adjusted. In variant configuration, changes to the configuration model, in other words, to material BOMs, object dependencies etc., have higher priority. Therefore, you should only edit bills of material in variant configuration in situations where changes to material BOMs should be transferred to the order BOMs

5. If you want to make different changes to an assembly that is used more than once, you first have to replace the material on one of the nodes.
6. If you want to make sales-order-specific changes to an assembly that has not yet been saved as order-specific you should fix the material BOM.
7. You go to the single-level order BOMs and carry out the necessary changes there.
8. Transfer bills of material to Project System if necessary.



We recommend you assign IDs to the components as soon as possible, where the material number is to be replaced. These should also be fixed. Only then should you transfer the bills of material to Project System. By doing this you avoid additional postprocessing.

9. Go to the BOM explosion screens if you need to, so you can display and print the multi-level BOM.



We recommend that, after every change to a bill of material (for instance, after a revaluation in variant configuration, or after fixing or editing a single-level order BOM) you click , so that the system explodes the bill of material again and displays the current status. This is important if you change a component quantity, for example. This can lead to the system selecting a different alternative BOM during [Alternative Determination \[Ext.\]](#)

Alternatively to that, in the order browser screen you can set: Setting the indicator *Autom. Update*. When you do this, the system updates the multi-level BOM after each change.

## Navigation in the Order Browser

### Use







In the order browser display the multi-level BOM for a sales order item and navigate to the processing and reporting functions for order BOMs. You can display configurable assemblies as well as non-configurable assemblies.

### Features

#### Object-specific functions

You call up the object-specific functions from symbols in the overview tree as well as from the context menu.

#### Symbols in the overview tree

Symbol	Description	By clicking ...
	BOM header	On the right mouse button, you display the context menu with the processing functions for order BOMs.
	BOM item	
	Subordinate assembly has a material BOM	
	Subordinate assembly has an order BOM	
	Configuration is complete	You display the assigned values. You can then change these in variant configuration.
	Configuration is incomplete or locked	
	Original exists (only document item)	You display the original file.

By clicking on the right mouse button, you call up the **context menu** for a BOM header or a BOM item. The functions that can be carried out in the processing situation are listed in the context menu.

#### Display functions

- Expand subtree
- Display (item overview or item detail screen)
- Expand in a new window of the WBS BOM browser

#### Processing functions

- [BOM transfer into the project system \[Ext.\]](#)





### Navigation in the Order Browser

- Create order BOM (for BOM items)
- [Material exchange \[Page 69\]](#) (for non-configurable BOMs)
- [Fixing \[Page 71\]](#) – single-level (for material BOMs)
- Fixing – multi-level (for material BOMs)
- Change (for order BOMs)
- Change with change number (for order BOMs)
- Process in the Engineering Workbench

### General functions

In the application function list, you call up the functions of the entire multi-level BOM for sales order items.

#### Symbols in the application function list

Symbol	Function	Description
	Find	With this function you look for character strings in the overview tree.
	Print	
	Layout	You can define several layouts with which you determine what information is displayed in the overview tree.
	Find object	With this function you look specifically for materials, documents and classes in the overview tree. The system automatically expands the subtree in which the searched for object was found and highlights it.
	Refresh	Explodes the BOM and refreshes the display in the overview tree.

From the *Goto* menu, the reporting functions as well as the other functions for order BOMs appear.

## Calling up the Browser

1. From the SAP Easy Access menu, choose *Logistics* → *Production* → *Master data* → *Bills of material* → *Bill of material* → <BOM type> → *Multi-level* → *Browser*.

You see the initial screen of the browser.

2. Enter the identified data for the BOM, the BOM application and also a date or a change number.

If you enter a change number here, the system uses this change number to explode the multi-level BOM in the overview tree. The change number on the initial screen of the browser is **not** valid for changes that you then carry out to the single-level BOM.



If you click  the system displays a list of the last ten BOMs displayed in the browser.



If you now click  the system displays other data from the environment of the selected BOM on the initial screen.

3. If you are working with large BOMs and only want to display the assembly on the top level of the multi-level BOM, enter a value for the maximum explosion level.

2. Click on  to enter the settings for explosion and display. You can

- Define the view. For more information, see the component *PS – Project System* under [Define view for BOM explosion \[Ext.\]](#).
- Restrict the view.
  - Using the indicator *Ltd Explosion* (Limited Explosion) you can select whether BOM items kept in stock should be exploded further. For more information, see the component *PP - BOMs* under [Restrict view for BOM explosion \[Ext.\]](#).
  - Using the indicator *Var. Display Depth* (Variable Display Depth) you can specify that only a section of the multi-level BOM is displayed in the order browser. You can find further information in [Variable display depth \[Page 178\]](#).
- Specify whether the multi-level BOM should be automatically up-dated after each processing step.
- Select whether the overview tree and the processing functions are displayed in the same window.

If you do this, the overview tree is displayed in the left or top screen area. If in the context menu of a BOM header or of a BOM item you select a processing function, the system displays this function in the right or bottom screen area.



Before you switch to another processing function remember to save, or click .

5. Click .

---

Calling up the Browser

## Variable Display Depth

### Use

In the design, you do not usually process the entire multi-level BOM for a sales order item but rather you concentrate on a specific assembly. You often do not want to display the entire multi-level BOM for a sales order item in the overview tree of the order browser, rather only the subtree for the assembly you want to process.

### Prerequisites

You have set the *Variable disp. depth* (Variable display depth) indicator in the dialog box *Order browser: Settings*.

### Features

When you call up the order browser, the *Display Depth* dialog box appears. There, you select the material number of the assembly at the head of the subtree that you want to display.

If you want to display another subtree at a later date, click on , to go back to the *Display Depth* dialog box.

The following functions are available in the *Display Depth* dialog box:

Function	Procedure	Notes
Display subtree	Enter the material number for the assembly at the head of the subtree. Use the possible entries function to do this, if necessary.	If an assembly in the multi-level BOM is used on various different nodes, you can clearly identify a node using the information on levels and nodes in the entry help.
Displaying the whole multi-level BOM	Deselect the <i>Retain Variable disp. depth</i> indicator.	This results in the <i>Display Depth</i> dialog box no longer being displayed during the current session.



In the initial node the system displays the material for the sales order item in all processing situations. This is also the case when you only display a subtree.

### Activities

#### Activating Variable Display Depth

You activate variable display depth as follows:

You are in the initial screen of the browser.

1. Click .
2. The *Settings* dialog box appears.
3. Set the *Variable disp. depth* indicator.

### Variable Display Depth

4. Click .



## Display Log

### Use

If you execute one of the following functions in the browser, the system creates a log:

- Material exchange
- Fix – single-level
- Fix – multi-level

With the help of the log you can see which activities the system has carried out using these functions.

### Activities

In order to display the log choose *Extras* → *Logs*. You can choose which logs are displayed:

Function	Description
 <i>Current Log</i>	Displays the last log generated.
<i>Today's Log</i>	Displays all the logs for the BOM functions that the logged-on user has executed during the day.
<i>All Logs</i>	Displays a selection screen in which you can look for any log

## Engineering Change Management in the Order Browser

### Use

Please read the notes in this document if you process your BOM using a change number.

### Features

#### Selecting a Valid Development Level

If you enter a change number in the initial screen of the order browser, the system uses this change number to select the valid development level. The system determines the components that are valid on the valid-from date and displays them in the overview tree of the order browser and in the order analysis.

#### Parameter effectivity

When you have processed a BOM with reference to change numbers with effectivity parameters, the system displays the dialog box *Effectivity parameter assignment*. The system recommends the parameter values that you entered in the sales order, as a default. We recommend that you use these default values.

#### See also:

[Assignment of the Effectivity Parameters \[Ext.\]](#)

#### Changing an Order BOM with a Change Number

You always carry out assembly level changes in the order browser. If, in the order browser, you want to change an assembly using a change number, enter the change number in the initial screen for changing a **single-level** BOM.

## Order Analysis

### Use

You carry out an order analysis if you want an overview of all assemblies in the multi-level BOM for a sales order item.

### Features

In an order analysis, the multi-level BOM assemblies for a sales order item are displayed. The bills of material are displayed on a series of tab pages:

- Order BOMs
  - All order BOMs that exist for a sales order item.
- Detached order assemblies
  - All assemblies that have been created with reference to a sales order item, but are not yet integrated in the multi-level BOM. After processing has finished, no more assemblies should appear on this tab page. You can find further information in [Detached order assembly \[Page 23\]](#)
  - If a component within a detached assembly is itself an assembly, it is only displayed if it is an order assembly. The system also displays these on the tab page, with the detached assemblies, and sets the *sub-assembly* indicator.
- Material BOMs
  - All bills of material that have not been saved as order-specific, in other words the order-independent assemblies.
- BOM header invalid
  - Order BOMs whose headers are invalid on the *Valid from* date on the initial screen.
- BOM item invalid
  - Order BOMs that have no valid items on the *Valid from* date on the initial screen.
- Multiple assemblies
  - Assemblies that are used more than once in a multi-level BOM for a sales order item.

### List Functions

Each time, the BOMs from the individual tab pages are shown in a list. The following functions are available on this list, for example:

- Sort
- Filter
- Print
- Export (for example in table costing data)

For more information see: [ABAP List Viewer \(ALV\): Grid Control \[Ext.\]](#).

## Order Analysis

### Activities

If you are in the order browser, click  *Order Analysis*.

## Material Exchange in the Order Browser

### Use

You exchange the material to a node of a multi-level BOM for a sales order item if you want to carry out different changes to a **non-configurable** assembly that is used on various levels in one of the multi-level BOMs.



If you want to exchange the material of a **configurable** assembly, you use the instantiation in variant configuration. An instantiation is then particularly necessary if you have configured material BOMs differently to various nodes, and now want to fix. You can find further information about instantiation in [Instantiation of configurable materials \[Page 43\]](#).

Material exchange is necessary, is an assembly is used on more than one node and you

- Want to make order-specific changes to one of the nodes, but want to use the unchanged material BOM on the other nodes
- Want to make different changes to various nodes in the bill of material
- Transfer a BOM to Project System

### Prerequisites

The BOM whose header material you exchange, must be a material BOM.

The superior BOM, that means the BOM that contains the components to be exchanged, has to be an order BOM.

If you work with variant configuration, we recommend that you close the configuration before you start the material exchange. You [instantiate \[Page 43\]](#) configurable assemblies in variant configuration.

### Features

The system creates a new material master record and **for the selected nodes** an order BOM. Consequently, data is copied from the original material master record and items are copied from the original BOM.

You can select the scope of the data to be copied:

- If you only transfer the *basic data for a plant*, the system copies the basic data and the MRP data to the plant of the sales order. You get a material master record that only contains the data that is required for a material exchange. You can enhance this material master record manually.
- If you select *maximum transfer*, the system also copies additional data that is available in the original material master record, such as sales and distribution and costing data. Consequently only the data for the plant of the sales order or, if not available, the group data is copied.

## Material Exchange

# Material Exchange

## Prerequisites

The superior assembly must already have been saved as order or project-specific.

## Procedure

1. Select the BOM header whose material you want to exchange.
2. Open the BOM header context menu with the right mouse button and select *Material Exchange*.

The *Setting Material Data* dialog box appears.

3. Select which data you want the system to create in the material master.

- Basic data for plant
- Maximum transfer

4. Enter a material number and a description for the new material.

If you do not enter a material number, the system assigns a material number from an internal number range.

5. Click .

The system carries out the material exchange.

## Result

The system

- Creates a new material master record with the new material number
- Copies the BOM for the previous material and saves it as an order BOM, whose header is then assigned the new material number
- Replaces the previous component in the superior order BOM item with a component that has the new material number
- Writes a [log \[Page 180\]](#), in which system activities during the material exchange are documented.

## Fixing a BOM in the Order Browser

### Use

You fix a material BOM if you want to make order-specific changes to the bill of material. In the order browser, you use this function primarily for non-configurable BOMs.

### Prerequisites

You have created a sales order. You have not yet saved the bill of material you want to fix, as order-specific.

### Features

When you fix a bill of material, the system creates an order-specific copy of the material BOM. In other words, it generates an order BOM from a material BOM. If you fix a BOM in the order browser, the system saves the data in the same way as for [fixing \[Page 46\]](#) a [result-orientated order BOM \[Page 41\]](#) in the variant configuration.

You fix	The system creates an order BOM that contains the following components:
A non-configurable material BOM	The same components as the material BOM
A configurable material BOM	<ul style="list-style-type: none"> <li>• All non-variable parts (components without object dependencies)</li> <li>• The variable parts (components with object dependencies), which the system selected as a result of the values assigned to the characteristics.</li> </ul>

You can fix a bill of material on a single-level or on multiple levels. When you fix a bill of material on a **single-level**, the system creates just the one order BOM.

When you fix a bill of material on **multiple-levels**, the system generates order-specific copies for all subordinate material BOMs as well. The BOM, with which you trigger the multi-level fix, has to be a material BOM. The system creates order BOMs for all material BOMs of the subtree. If a subordinate assembly already has an order BOM the system leaves it as it is. If however, there are still material BOMs under such an order BOM, these are fixed.

### Order BOMs for Configurable Materials

If you use this function to fix an order BOM for a configurable material, you will always see a **result-orientated** order BOM.

If you call up the variant configuration at a later date, do not forget that a configurable order BOM is merged with a material BOM that has the same material number.

You can stop the merge operation with the help of a customer enhancement.

#### See also:

[Merging with Global Material BOMs \[Page 49\]](#)

## Fixing a BOM in the Order Browser

## Fixing a BOM in the Order Browser

1. In the context menu of the BOM header, select the command *Fix BOM – single-level* or *Fix BOM – multi-level*.

If one or more assemblies in the multi-level BOM for a sales order item are used more than once, then the system displays the dialog box *Assemblies occur more than once*. Decide how you wish to proceed:

- Click  if you want to fix the assembly regardless.
 

Consider that the order BOM then replaces all instances of the material BOM in the multi-level BOM.
- Click , to cancel the process if you first want to carry out a material exchange or want to instantiate the assembly.

**Also see:** [Material Exchange in the Order Browser \[Page 69\]](#)

2. The dialog box *Fix confirmed* is displayed with a list of all material BOMs.

The system fixes all BOMs marked in this list. As standard all BOMs in the list are selected. If you do **not** want to fix a certain BOM, then remove the relevant flag.



Keep the CTRL key pressed down in order to select several BOMs or to remove the flags for several BOMs.



In the column *I/C* the dependent requirements for individual and collective requirements are displayed. If this indicator *only* applies for *collective requirements*, then you have to change it in the order BOM, so that the BOM is taken into consideration in MRP. For more information, see [Order BOMs in MRP \[Page 116\]](#)

If you want to create WBS BOMs instead of order BOMs continue with the procedure in [Fixing Order BOMs or WBS BOMs \[Ext.\]](#).

3. In the *Confirm fixing* dialog box, click .

The system fixes the BOMs. It then writes a [log \[Page 180\]](#), in which system activities during fixing are documented.

4. In the order browser, click , to update the display.

The order BOMs are displayed in the order browser. You can now process them.



The system creates the order BOMs with today's date.

If you do not enter a date on the initial screen of the order browser, the system sets the default date. In certain cases this default date can be before today's. If you **display** the multi-level BOM in the order browser on this date, then in certain cases, the order BOM is not yet valid and will not be displayed. If that is the case, then go back and select another date on the initial screen.





## Example: Multi-Level Fixing in the Order Browser

**Example: Multi-Level Fixing in the Order Browser**

You have entered Material A in item 10 of sales order 821. In the multi-level BOM, C is the header material of a sub-tree. You want to redesign assembly C and all subordinate assemblies for the sales order.

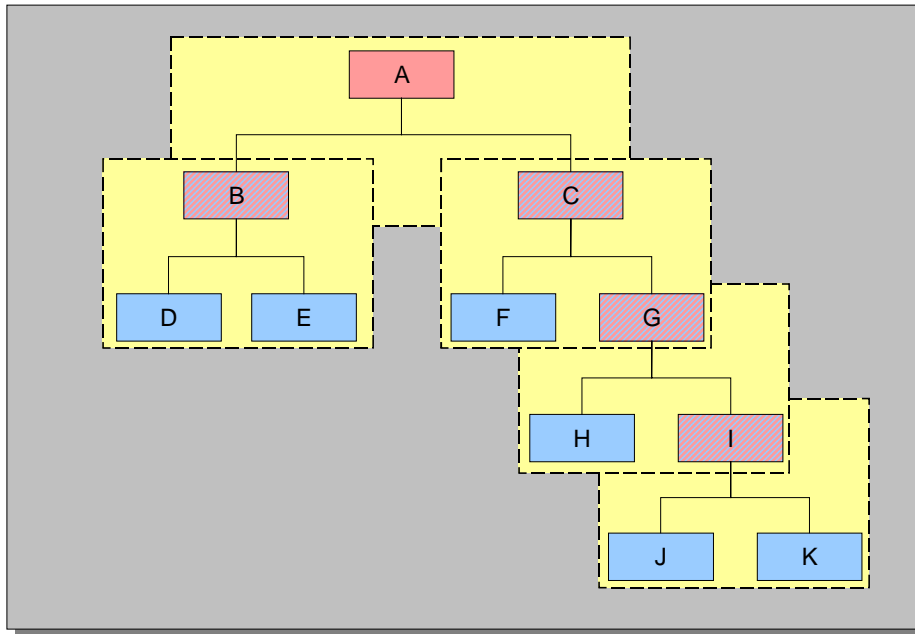
**Multi-Level BOM before Fixing**

You select the BOM header in assembly C and fix the bill of material on multiple levels. Following this, the system saves all subordinate bills of material as order-specific:

**After the Multi-Level Fixing of the Sub-Tree under Assembly C**

Example: Multi-Level Fixing in the Order Browser

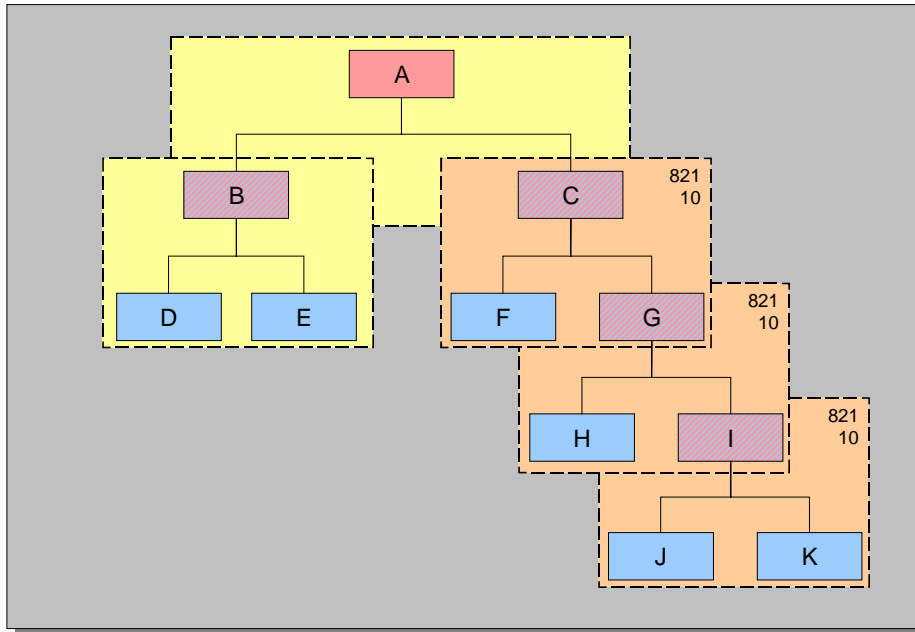

## Multi-Level Copying

# Multi-Level Copying

## Use

You use this function if you want to reuse an assembly that you have already configured in the past, and for which you may already have created order BOMs. With this function you transfer a multi-level BOM, including the characteristic values and all subordinated order BOMs, from either a quotation or from an existing sales order.



For example, you have created a quotation for a configurable material, assigned values to the configuration characteristics and carried out manual changes to several assemblies. Once the customer has accepted the quotation, you convert it into a standard order. You then copy the entire multi-level BOM including the characteristic values for the subordinate assemblies and order BOMs from the order browser, into the standard order.

Instead of copying the entire multi-level BOM, you can also copy just an assembly or subtree.



For example, you produce a product for a customer for whom, in the past, you have produced the same product. In a particular assembly, the customer wants to make exactly the same modification as in the previous sales order. Instead of changing the BOM from scratch again, you simply copy the order BOMs level by level from the previous sales order into the new one.

## Prerequisites

You have already created both the source and target order.

If you work with variant configuration, then you selected the result-oriented order BOMs from the configurable assemblies configuration profile. Furthermore, in the target order you have assigned values to the characteristics of the sales order item materials (single-level configuration). The characteristic values in the target order have to be identical to those in the source order.

If you copy a subtree, then the header material of the subtree can only be used in **one** node of the multi-level BOM for the sales order item. If you want to use it for several nodes, you first carry out a [Material exchange \[Page 69\]](#) or an instantiation.



SAP recommends that you only use the *Multi-level copying* function if the same material has been entered in the sales order items of both the source and target orders. However, in certain cases, exceptions to this rule can make sense. For example, you want to reuse pump P-100, that you configured for customer A in turbine T-10000, in turbine T-20000 for customer B. In such cases a control and post-processing are necessary. This depends on the responsibility of the person who processed the BOM. **If the configuration profiles in the source and target are different, this can lead to unforeseeable results.**

## Features

The system copies:

- The characteristic values of all configurable assemblies  
The only exception to this is the characteristic value of the sales order item material.
- All order BOMs in the subtree  
You can select whether order BOMs that already exist in the target order are allowed to be overwritten. If you have already created order BOMs in the target order that should be kept, then switch off the overwrite mode. Then the system removes the order BOMs that already exist in the target order, from copying.

If the system copies order BOMs, then in the relevant nodes, the material BOMs in the target order are replaced by order BOMs. If the header material of the subtree that you are copying does not exist in the multi-level BOM for the new sales order item, then the system generates [Detached order assemblies \[Page 23\]](#).

Before you copy a BOM level by level, you can first carry out a **simulation**, in order to display a list of the order BOMs that are planned for copying.

## Copying a BOM Level by Level

## Copying a BOM Level by Level

### Procedure

You are on the *Order BOM: Initial Screen* screen.

1. Enter the sales order number and the sales order item of the **source order**, that is to say, the sales order, whose BOM you want to copy.
2. Select *Goto* → *Copy level-by-level*.

The *Copy level-by-level* dialog box appears.

3. In the group box *Source order* enter the header material of the assembly that you want to copy.

If you want to copy the entire multi-level BOM for the sales order item, you can leave the *Material* field empty.

4. In the group box *Target order* enter the sales order number and item.

If you enter a change number here, then the system creates all order BOMs in the target order with reference to this change number.

5. Determine the options for the multi-level copy.

With the *Material exchange* option, you determine whether a material master record replaced in the source order has to be replaced again in the target order. If you:

- **set** the indicator, the system checks whether material master records exist in the source order that were created in the order browser with the function [Material exchange \[Page 69\]](#). If that is the case, then in turn the system creates new material master records for these materials in the target order.

For example, this is useful if you assign sales order specific material numbers during the material exchange.

- **do not set** the indicator the system uses the unchanged material number from the source order.

6. Click .

The system starts the copying process.

### Result

After copying, the system displays a list of the copied order BOMs.



If one or more order BOMs could not be copied, then the system displays a list of these order BOMs as well. For example, this can be the case if an order BOM is locked by another person who is currently processing it.

Now the **target order** is displayed in the order browser.

## Order BOM Editing

### Use

With this function you change a non-configurable order BOM.

### Prerequisites

You have fixed a material BOM or manually created an order BOM.

The same prerequisites apply here, as for editing material BOMs. You can find further information in the *Bills of Material* documentation in [Before you Change a BOM \[Ext.\]](#).

You can change an order BOM with this function, if you either created it for a non-configurable material, or if the system saved the order BOM as result-oriented in variant configuration.

### Features

If you enter the order-specific components in an order BOM, you work as you would when editing a material BOM.

You can extend an order BOM, by transferring items from an existing order BOM or material BOM.



It is not possible to transfer items from a configurable BOM.

More than one person can edit different assemblies in a multi-level BOM at the same time. A single assembly can, however, only be edited by one person at a time. This assembly is then locked to other users, until it is saved.

The following restrictions apply to order BOMs:

- A result-oriented order BOM is non-configurable. Therefore, you cannot create [class items \[Ext.\]](#) in these bills of material either.
- You can't create [alternative BOMs \[Ext.\]](#) for an order BOM.
- You can't create [variant BOMs \[Ext.\]](#) for an order BOM.
- When you change an order BOM, you can work with change numbers, but not with revision levels.



Click  when you have finished editing an order BOM, so the system determines the newly current components in the order BOM.

## Changing an Order BOM

## Changing an Order BOM

### Prerequisites

You have manually created the order BOM you want to change or, the system saved the order BOM as result-oriented during variant configuration.

### Procedure

1. Choose *Logistics* → *Production* → *Master data* → *Bills of material* → *Bill of material* → *Order BOM* → *Change*.

The *Change Order BOM: initial screen* appears.



If you are working with the [order browser \[Page 51\]](#), choose the context menu for the BOM header instead.

- *Change*, to go directly to the item overview. In this case go straight to step 3.
  - *Change with change number*, to go to the *Change order BOM: Initial screen*
2. Enter the sales order number, the order item, the material number and the BOM usage and then click

The item overview appears.

3. Change the items similarly to editing item data in material BOMs. Take note of the limitations related to order BOMs (see [Editing an Order BOM \[Page 79\]](#)).
4. If you want to transfer items from a material BOM or an existing order BOM, proceed as follows:
  - a. Choose *Edit* → *Extend* → *Extend order BOM* or *Extend material BOM*.
  - b. The *Copy order BOM* or *Copy material BOM* dialog box appears. Enter the BOM you want to use as a reference and click .



You cannot use a configurable BOM as a reference.

The item overview appears, for the bill of material from which you want to transfer items.

- c. Select the items you want to copy to the order BOM and click .
  - d. The item overview for the BOM you want to change appears. The items you transferred are displayed in the item overview.
5. Save your order BOM.



## Displaying Order Bills of Material

### Prerequisites

You have manually created the order BOM you want to display, or the system saved the order BOM as result-oriented during [variant configuration \[Ext.\]](#).

### Procedure

2. Choose *Logistics* → *Production* → *Master data* → *Bills of material* → *Bill of material* → *Order BOM* → *Display*.

If you are working with the order browser, choose the *Display* command in the context menu for the BOM header instead.

2. The *Display Order BOM* initial screen appears. Initial screen.
3. Enter the sales order number, the order item, the material number and the BOM usage and then click .

The item overview appears.

You can find further information on displaying bills of material in the *Bills of Material* documentation in [Steps for Displaying a Simple Material BOM \[Ext.\]](#).

---

**Transferring BOMs to the Project System**

## Transferring BOMs to the Project System

### Use

You use the order browser for BOM transfer, if you want to transfer a bill of material on a particular node of the overview tree to Project System.

### Prerequisites

Here, the general prerequisites apply for the BOM transfer into the project system. For more information, see the component *PS – Project System* under [BOM transfer \[Ext.\]](#).

You have ensured that no assembly in the multi-level BOM for the sales order item is used more than once. For more information, see [Transfer and Assemblies Used More than Once \[Ext.\]](#).

The *New Version* indicator is set on the *BOM browser: Settings* screen.

### Procedure

You are in the order browser.

1. If necessary, select , to ensure that you are using the current processing status.

The system re-explodes the multi-level BOM.

2. Select the header of the BOM that you want to transfer to the project system.
3. In the context menu of the BOM header select *BOM transfer PS*.

You see the *BOM Transfer* screen. The following fields are already preassigned and are not ready for input:

- Sales document (sales order number)
- Sales document item (sales order item)
- Material
- Plant
- BOM Usage

In the following fields you find default values that you can overwrite:

- BOM type (material BOM or sales order BOM)
- BOM application
- Requirements quantity

4. Enter the data that is not yet preassigned and click .

#### See also:

[BOM transfer into the project system \[Ext.\]](#)

## Multi-Level Order BOM Reporting

### Use

With these functions you gain an overview of a multi-level BOM for a sales order item. You use the reporting functions for order BOMs, similarly to those for material BOMs. You can find further information in [Reporting Functions \[Ext.\]](#).

#### BOM Reporting Functions

Aim of the Report	Function
Gain an overview of the structure of your bill of material	<a href="#">BOM Explosion [Page 84]</a>
Display a list of the uses of a material in order BOMs	<a href="#">Where-Used List [Page 90]</a>
Compare an order BOM, for example, with another order BOM or a material BOM	<a href="#">BOM Comparison [Page 91]</a>

---

**BOM Explosion**

## BOM Explosion

### Use

You use this function to gain an overview of a multi-level BOM for a sales order item.

### Features

You can display a multi-level BOM for a sales order item in the following ways:

- As a list sub-divided by assemblies
- As a hierarchically structured list
- As an overview of the quantities of all parts required to assemble a product



When the system explodes a multi-level BOM for a sales order item, it ignores any [detached order assemblies \[Page 28\]](#). These are order assemblies, which you have not yet inserted into the multi-level BOM.

## Displaying BOMs Level by Level

### Use

You use this function if you want to display the components for every assembly in the multi-level BOM for a sales order item.

### Prerequisites

On the screen *BOM level by level: View* (see [Extending the View for BOM Explosion \[Ext.\]](#)) the *multi-level* indicator must be set.

### Procedure

1. Choose *Logistics* → *Production* → *Master data* → *Bills of material* → *Bill of material* → *Reporting* → *BOM explosion* → *Order BOM* → *BOM level by level*.

The *BOM Level by Level: Initial Screen* appears.

2. Enter the sales order number and the order item.
3. In the *Application* field, enter the key of the procedure for automatic alternative determination.





On the initial screen you do not have to enter a material number. In multi-level order BOM explosions, the whole bill of material (from the material in the sales order item) is always displayed. If you are interested in a particular assembly from an extensive bill of material, it can help to enter the material number of the header material for this assembly on the initial screen. You can then see the assembly on the screen straight away without having to scroll.

4. Enter data for [selecting a BOM \[Ext.\]](#) if necessary.



For the required quantity the system automatically proposes the order quantity from the sales document. This value can not be changed here.

5. Click  and enter the selection criteria for BOM explosion.
6. Click .

### Result

You see a list of all items that fulfill your selection criteria. The quantities refer to the required quantity displayed in the list header.

- In the reporting list for *BOM level by level*, you first see all components on the first level. For components that are themselves assemblies, the *Asm* (assembly) indicator is set.
- If a component is itself an assembly, its components are displayed in a separate block. You see all the assemblies that exist for components of the previous level.



An assembly is not exploded under certain circumstances.

---

**Displaying BOMs Level by Level**

- If a class node exists in a multi-level BOM, the material that results from the value assignment is displayed in the reporting list. However, if this material is an assembly, its components are no longer displayed in the reporting list.
- You can find further reasons for a BOM explosion being terminated in [When is a BOM Explosion Terminated? \[Ext.\]](#)

## Displaying a Multi-Level BOM Explosion

### Use

You use this function if you want to display all components in the multi-level BOM for a sales order item in a structure.

### Procedure

1. Choose *Logistics* → *Production* → *Master data* → *Bills of material* → *Bill of material* → *Reporting* → *BOM explosion* → *Order BOM* → *Multi-level BOM*.

The *Structure Level by Level: Initial Screen* appears.

2. Enter the sales order number and the order item.
4. In the *Application* field, enter the key of the procedure for automatic alternative determination.





On the initial screen you do not have to enter a material number. In multi-level order BOM explosions, the whole bill of material (from the material in the sales order item) is always displayed. If you are interested in a particular assembly from an extensive bill of material, it can help to enter the material number of the header material for this assembly on the initial screen. You can then see the assembly on the screen straight away without having to scroll.

5. Enter data for [selecting a BOM \[Ext.\]](#) if necessary.



For the required quantity the system automatically proposes the order quantity from the sales document. This value can not be changed here.

6. Click  and enter the selection criteria for BOM explosion.
7. Click .

### Result

You see a list of all items that fulfill your selection criteria. The quantities refer to the required quantity displayed in the list header.

- In the *multi-level BOM* reporting list - as opposed to the *level by level BOM* reporting list - the components in an assembly are displayed directly underneath the assembly and have a higher level number.
- If a component is itself an assembly, first the components in the subordinate assembly are listed directly beneath it. Only then is the listing of the components in the superior assembly continued.



An assembly is not exploded under certain circumstances.

---

**Displaying a Multi-Level BOM Explosion**

- If a class node exists in a multi-level BOM, the material that results from the value assignment is displayed in the reporting list. However, if this material is an assembly, its components are no longer displayed in the reporting list.
- You can find further reasons for a BOM explosion being terminated in [When is a BOM Explosion Terminated? \[Ext.\]](#)



## Displaying a Summarized BOM

### Use

In certain application areas in a company, such as material requirements planning (MRP) and costing, you need an overview of all the components required to make a product. A summarized BOM offers a complete listing of the assemblies and individual components in a product structure.

### Procedure

1. Choose *Logistics* → *Production* → *Master data* → *Bills of material* → *Bill of material* → *Reporting* → *BOM explosion* → *Order BOM* → *Summarized BOM*.

The *Summarized BOM: Initial Screen* appears.

2. Enter the sales order number and the order item.
5. In the *Application* field, enter the key of the procedure for automatic alternative determination.





On the initial screen you do not have to enter a material number. In multi-level order BOM explosions, the whole bill of material (from the material in the sales order item) is always displayed. If you are interested in a particular assembly from an extensive bill of material, it can help to enter the material number of the header material for this assembly on the initial screen. You can then see the assembly on the screen straight away without having to scroll.

6. Enter data for [Selecting a BOM \[Ext.\]](#) if necessary.



For the required quantity the system automatically proposes the order quantity from the sales document. This value can not be changed here.

7. Click  and enter the selection criteria for BOM explosion.
6. Click .

### Result

You see a list of all items that fulfill your selection criteria. The quantities refer to the required quantity displayed in the list header.

- This reporting function produces a **complete** count of the components across all levels in a product structure.
- This list does not show you the structure of the product. Individual components which occur more than once in the product are displayed as one item, with a sum total item quantity.

---

**Where-Used Lists**

## Where-Used Lists

### Use

You use this function if you want to know in which order assemblies and for which orders a material is used.

### Features

The system displays a list of the order BOMs with order number and order item, in which a material is used. You can find further information in the *Bills of Material* documentation in [Where-Used Lists \[Ext.\]](#). As opposed to where-used lists for material BOMs, where-used lists for order BOMs are always single-level.



The system also displays components in [detached order assemblies \[Page 28\]](#). These are assemblies, which you have not yet inserted into the multi-level BOM for the sales order item.

## BOM Comparison

### Use

You use this function to compare an order BOM with, for instance, another order BOM or a material BOM.

### Features

The system displays a list in which the same, similar and different items belonging to two bills of material are shown side-by-side. You can find further information in the *Bills of Material* documentation in [BOM Comparison \[Ext.\]](#).



You can also compare a detached order assembly with another assembly.

## Order-Specific Component Assignment in Routings

# Order-Specific Component Assignment in Routings

## Use

You use automatic component assignment when you work with order BOMs and when you also want to use the component assignments that you have created for your material BOMs for order BOMs.

## Prerequisites

You have already assigned the header material of a material BOM to a routing. You have created operations in this routing.

Assignments already exist between the routing operations and the components of the material BOM.

## Features

### Component Assignment in the Configuration Editor

When you fix a BOM in the configuration editor, the system automatically creates the following data:

- A new material-routing assignment  
The system assigns a combination of material number, sales order number and sales order item to the routing header.
- Order-specific component assignment  
The system creates an assignment between the operation and order BOM component for each assignment between an operation and a material BOM component as long as you have not deleted this component.



The system does **not** create an order-specific routing. The operations are **not** saved as order-specific.



If you call up the configuration editor again at a later date, it may then be necessary to manually trigger the component assignment in the order browser.

### Component Assignment in the Order Browser

If you post-process an order BOM outside of the configuration or you create new order BOMs, you then trigger an automatic component assignment in the order browser.



If you fix a BOM in the order browser, the system does **not** carry out automatic component assignment. This has to be triggered explicitly in the order browser.

---

## Order-Specific Component Assignment in Routings

### Processing Order-Specific Component Assignments

If you process a routing and enter a material number, sales order number and a sales order item in the selection parameters, the system displays the order-specific component assignments.

### Activities

To trigger an automatic component assignment in the order browser for all order BOMs for a sales order item, proceed as follows:

You are in the order browser.

1. Choose Extras → *Autom. Comp. Assignment*.

When you trigger the component assignment for the first time, the system carries out the assignment immediately. The following steps do not apply.

If you repeat the component assignment you go to the dialog box *Component Assignment*.

2. If you want the system to delete all existing order-specific component assignments before it creates new component assignments, choose *Delete the order-spec. assignment*.
3. When you want to verify that the system is reading the current processing status from the database, make sure that the *work with internal buffering* indicator is **not** set.
4. Click .

---

**Costing of Order BOMs**

## Costing of Order BOMs

### Use

In sales order processing you basically use two costing functions:

- [Sales order costing \[Page 95\]](#)
- [Order BOM cost estimate \[Page 109\]](#)

## Sales Order Costing

### Use

You can create a cost estimate for the following sales document types:

- Inquiries
- Quotations
- Sales orders

The cost estimate costs the specific sales document **item**.

The costing results are transferred to the sales document as a condition value. The system can calculate the net value of the sales transaction using conditions that access this value.

### Prerequisites

#### Control Parameters in Sales and Distribution (SD)

Before you can enter a cost estimate for a sales document, you must carry out the following steps in Customizing for *Sales*:

- Define a condition type for pricing through costing
  - You select the condition type with the field *CndType line items* in the sales document type. The condition type must have condition category Q (*costing*).
- Add this condition type to the SD pricing procedure
  - The SD pricing procedure specifies the conditions that are allowed for pricing a sales document. It also specifies the sequence in which the conditions are included. The results of the cost estimate can only be included if the pricing procedure specifies an appropriate condition type and appropriate access sequences.
- Enter default values for costing in the requirements class
  - The requirements class specifies the following:
    - Whether a sales order cost estimate must be created, can be created, or can only be simulated
    - Whether the cost estimate is manually created, automatically created, or automatically created and marked
    - Which costing methods are allowed. There are two costing methods: product costing and unit costing. You use product costing when you want to cost an existing quantity structure for a sales order item. You use unit costing when you want to enter the individual costing items manually, instead of specifying an existing quantity structure.
      - You can use the functions of unit costing to modify the costs in a product cost estimate, for example to add additional costs or to reflect customer-specific changes in the quantity structure.
  - The requirements class also determines:
    - The default costing variant for the sales order item
    - The default costing sheet for the sales order item

## Sales Order Costing

- Whether this costing sheet is passed on to the dependent production orders (indicator *Copy costing sheet*) For more information, refer to the section [Overhead in Sales-Order-Related Production \[Ext.\]](#)

You can check the requirements class in Customizing for *Product Cost by Sales Order*. The documentation in the Implementation Guide contains detailed information on the settings for the requirements class.

## Control Parameters in Materials Management (MM)

The sales order cost estimate takes into account materials that are being produced or procured especially for the sales order and materials that are withdrawn from the make-to-stock inventory in different ways. In the MRP view of the material master record, you specify whether the materials used by the material in the sales order item are individual requirements materials or collective requirements materials (indicator *Individual/collective*).

This ensures correct cost rollup with collective requirements materials.



To enable product costing to separate the costs for individual requirements materials from the costs for collective requirements materials, make sure that these materials have different accounts (and therefore different primary cost elements) when you define the material account assignment in *Materials Management*.

The costs will then be shown on different accounts. Differential overhead allocation is possible.

## Control Parameters in Product Cost Controlling

### Product Costing

To cost sales orders with the functions of product costing, you must define the following parameters in Customizing for *Product Cost Controlling*:

- Costing variant
- Costing type
- Valuation variant
- Transfer strategy
- Date control
- Quantity structure determination
- Cost components

### Unit Costing

To cost sales orders with unit costing, you must define the following parameters in Customizing for *Product Cost by Sales Order*:

- Costing variant
- Valuation variant



## Features

When a sales order cost estimate is created, this has the following effects:

- **The conditions are updated in SD.**
- **The planned costs are updated to the sales order item.**

These functions are **not** performed on the [order BOM cost estimate \[Page 110\]](#).

You can create a sales order cost estimate:

- Using a product cost estimate for the multilevel BOM for the sales order item
- With unit costing
- By creating a product cost estimate and modifying it with unit costing

In the cost estimate for the sales order item, you can:

- Use the lot size of the sales order as the basis for calculating the planned costs
- Determine the quantity structure for the product through the configuration in the sales order
- Include the costs of raw materials and trading goods procured externally when costing the sales order
- Calculate overhead rates based on contractual terms unique to the sales order

The system creates a cost estimate for the sales order item. At the same time, the system updates the planned costs on the sales order item (see also: [Update of Planned Costs \[Ext.\]](#)).

You can transfer a cost component split calculated in a sales order cost estimate to *Profitability Analysis*. This allows the cost components to be seen in *Profitability Analysis*.

A requirement here is that you calculate the planned costs for the sales order cost estimate in a product cost estimate.

If you calculate the planned costs with unit costing, or use unit costing to modify the costs in a product cost estimate, you cannot transfer a cost component split to *Profitability Analysis*.

You define the transfer by cost component in Customizing for *Profitability Analysis* under *Master Data* → *Valuation* → *Product Costing* → *Define Access to Product Costing* with the indicator *Transfer sales order cost estimate*.



### Note on Costing Sales Order Items with Valuated Sales Order Stock

The status *Cost* is only set if you specified in the requirements class that costing is required. This means that if costing is not required, a cost estimate with errors (status KF) will not cause the status *Cost* to be set.

Therefore, if you change the quantity, the configuration, or the pricing date for sales order items, it may be appropriate to create a new sales order cost estimate. In many cases, however, it is not necessary to create a new sales order cost estimate. Depending on the Customizing settings, the system proceeds as follows:

## Sales Order Costing

### Case 1:

#### Prerequisites:

In Customizing for *Product Cost by Sales Order* in the requirements class, it is specified that a cost estimate should be created automatically. No marked sales order cost estimate (status VO) exists at the time the quantity, the price, or the configuration is changed.

#### The system responds as follows:

These changes result in the system automatically recosting the sales order item when you save.

### Case 2:

#### Prerequisites:

In Customizing for *Product Cost by Sales Order* in the requirements class, it is specified that a cost estimate should be created automatically. A marked sales order cost estimate (status VO) exists at the time the quantity, the price, or the configuration is changed.

#### The system responds as follows:

Since a marked cost estimate already exists that may already have been used for valuation, the system does not automatically recost the sales order item. If you want the changes to affect the sales order cost estimate, you must manually initiate costing. The new cost estimate does not result in revaluation of sales order stocks that have already been valued. Variances are calculated on the basis of the new cost estimate.

### Case 3:

#### Prerequisites:

In the requirements class, it is specified that a cost estimate must be created. A marked cost estimate exists at the time of the change.

#### The system responds as follows:

The system does not automatically recost, since the marked cost estimate could already have been used for valuation. The status *Cost* is not set. If you want to recost nevertheless, you must initiate costing manually.

### Case 4:

#### Prerequisites:

In Customizing for *Product Cost by Sales Order* in the requirements class, it is specified that a cost estimate must be created. It is not specified that costing should be performed automatically. No marked sales order cost estimate (status VO) exists at the time the quantity, the price, or the configuration is changed.

#### The system responds as follows:

The system sets the status *Cost* (to be costed) for the sales order item. You initiate sales order costing manually (if required). The Customizing settings do not allow automatic costing.

Note the following: For all sales order items with the status *Cost*, no delivery to the customer can take place. If no marked sales order cost estimate exists at the time the goods are received into inventory, valuation uses one of the strategies specified in the valuation strategy. If none of these strategies work, no goods receipt can be posted.

## Sales Order Costing

For information on the valuation strategy with sales order stocks, refer to the SAP Library in the following section: [Update of Valuated Sales Order Stock \[Ext.\]](#)

You can generate a list of all sales order items with the status *Cost* with the report [Display Sales Order Items to Be Costed \[Ext.\]](#).

**Case 5:****Prerequisites:**

In the requirements class, it is specified that a cost estimate can be created. No automatic costing is to take place.

**The system responds as follows:**

Regardless of whether a marked cost estimate exists or not, the sales order item does not receive the status *Cost* with any of the changes, since due to the Customizing settings, it is assumed that the cost estimate is not used for valuation. A cost estimate can be created manually at any time.



If you have specified that costing is required but is not to be performed automatically, the system sets the status for the sales order item to *Cost* (to be costed) when the sales order is created.

The status *Cost* prevents subsequent functions such as delivery or invoicing from being performed until after the sales order has been costed. This is of particular value if pricing in *Sales and Distribution* is based on the results of the cost estimate.

The status *Cost* is also set when a faulty cost estimate is generated (status of cost estimate is KF) and the Customizing settings require a cost estimate. If the sales order cost estimate is successfully created (status of the cost estimate is KA), the sales order item receives the status *Cstd* (costed).

## Sales Order Costing

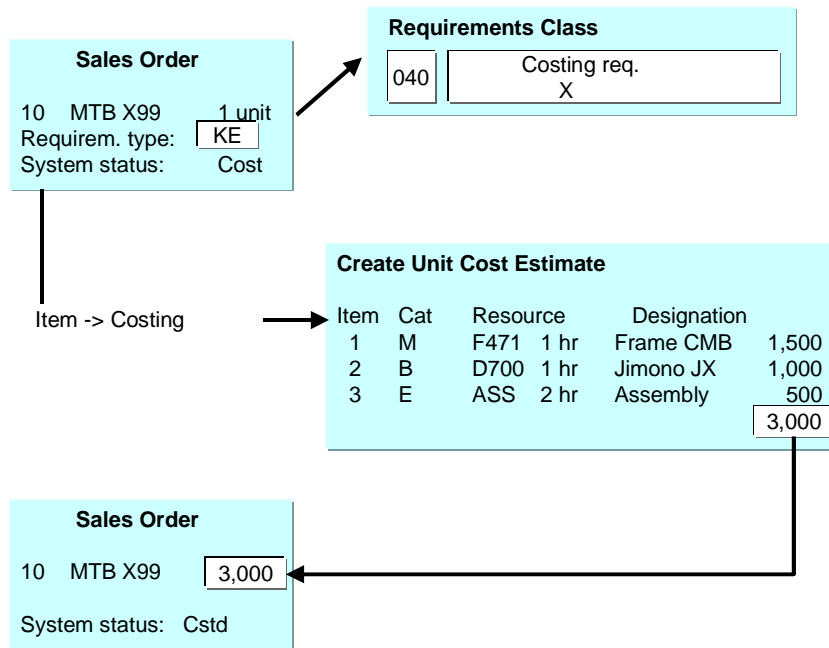

## Effects of Order BOM Cost Estimate on Status Update for Sales Order Item

- Can a status be updated for the sales order item?

The status update of the sales order item depends on the setting of the indicator *Costing* in the requirements class.

- Indicator is not set = Costing allowed, with status update
  - If the sales document item already has the status *Cstd*, this status is removed after an order BOM cost estimate for an assembly is created.
- A = Costing allowed, without status update
- If an order BOM cost estimate for an assembly of the order BOM of the relevant sales document item is created, the status of this sales document item is not changed.
- B = May not be costed
- If an order BOM cost estimate for an assembly of the multilevel BOM of the relevant sales document item is created, the status of this sales document item is not changed.
- X = Costing required
  - If costing is required for the sales document item, the sales document item receives the status *Cost* (to be costed) when it is created. When a sales order cost estimate is created, the sales document item receives the status *Cstd* (costed). If an order BOM cost estimate is created for an assembly of the multilevel BOM of this sales document item, the status *Cstd* is removed and the status *Cost* is set. This tells you how up-to-date the sales order cost estimate is.

The status update is made only for a sales order cost estimate. Order BOM cost estimates do **not** influence status update.

## User-Defined Error Management

You can influence the messages output in the log of sales order costing by using [user-defined error management \[Ext.\]](#).

### See also:

[Overhead in Sales-Order-Related Production \[Ext.\]](#)

[Overhead \[Ext.\]](#)

[Product Cost Estimate for Sales Order Item \[Page 102\]](#)

[Unit Cost Estimate for Sales Order Item \[Ext.\]](#)

For information on updating data in multiple valuation views, refer to the following section:

[Transfer Prices in Cost Object Controlling \[Ext.\]](#)

## Transfer Prices

If you are using transfer prices, you can update the planned costs calculated in a sales order cost estimate in multiple valuation views. To do this, you create a maximum of two [order BOM cost estimates \[Page 109\]](#) (in addition to the sales order cost estimate) with their own costing variants for the same sales document item.

## Product Cost Estimates for Sales Order Items

### Use

You can create a product cost estimate for a multilevel BOM for a sales order item. The material in a multilevel BOM for a sales order item can be a material with a closed BOM (nonconfigurable material), a configured material, or a material with an open BOM (configurable material) whose characteristic values were defined in the sales order item.

### Prerequisites

You can define the following default values in Customizing for *Product Cost by Sales Order* under *Control of Sales-Order-Related Production* → [Check Requirements Classes \[Ext.\]](#):

- Costing method
- Costing variant
- Costing sheet

The *Costing* indicator in the requirements class allows you to specify whether sales order items must be costed.

You can use the *Costing* indicator to control the time point at which the sales order is costed and the sales order cost estimate marked.



If you enter **A** (automatic costing) or **B** (automatic costing and marking), the sales order item is automatically costed, or automatically costed and marked, when the sales order is saved.

If you entered B but cost the sales order manually before you save the sales order, you must also mark manually.

If you don't enter anything, you must always manually cost and manually mark (**see also**: [Creating a Product Cost Estimate for a Sales Order Item Manually \[Page 107\]](#)).

You specify the following in Customizing for *Product Cost by Sales Order* under *Preliminary Costing* → *Costing Sales Order Items with Product Costing* → *Costing Variants for Product Costing* → [Check Costing Variants for Product Costing \[Ext.\]](#):

- Whether an itemization should be saved for the sales order cost estimate
  - The system requires the itemization if you are using a valuated sales order stock and if:
    - You want to calculate variances for the material and the standard price is calculated in a sales order cost estimate
    - You want to value work in process at target costs and calculate the target costs in the sales order cost estimate
    - You want to value scrap variances with the target costs calculated in the sales order cost estimate
- Whether the costing lot size is determined by the order quantity or by the lot size in the material master record

## Requirements Explosion

For example, you can specify that the lot size is only passed on for materials from individual requirements. You specify whether a material is an individual requirements material or a collective requirements material in the *MRP* view of the master record.

## Requirements Explosion

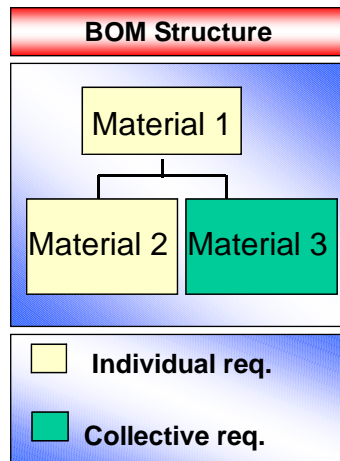

### Individual Requirements Ind.

- 1 - Only individual req.
- 2 - Only collective req.
- ' ' - Collective requirements and individual requirements

## Passing On the Costing Lot Size

## Passing On the Costing Lot Size

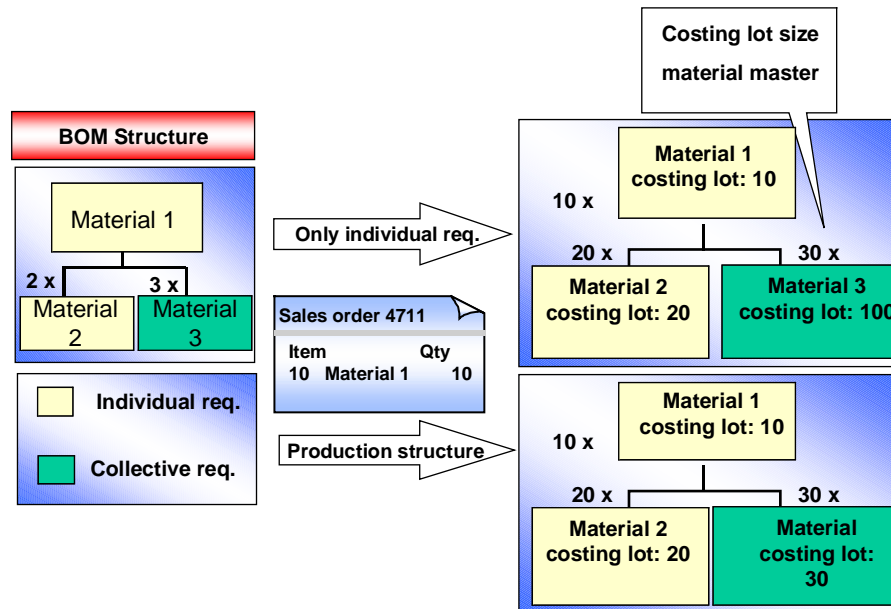

The settings for the costing lot size should not conflict with the transfer control.

- Costing type

The costing type determines the technical attributes of costing. For sales order costing, it also determines the following:

- Whether the costing sheet in the sales order item is used to calculate the overhead for individual requirements materials
- Whether overhead is calculated for externally procured individual requirements materials

- Valuation variant

In addition to the other settings in sales order costing, the valuation variant determines which costing sheet is used for the material components, depending on the costing type.

- Transfer control

The transfer control parameters determine whether a material is recosted when cost planning data for the material exist in the plant or controlling area of the finished product. Transferring existing costing data can significantly **improve performance**.

For example, you can specify that existing standard cost estimates should be passed on for all collective requirements materials.



## Transfer Control for Collective Requirements Materials

- Whether [order BOM cost estimates \[Page 109\]](#) should be transferred

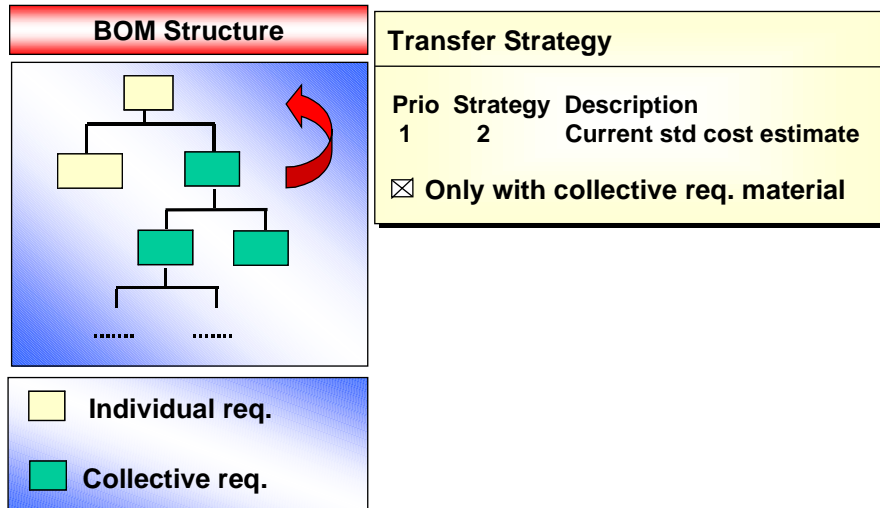

Transferring existing order BOM cost estimates can significantly **improve performance**.



You specify in the costing variant whether you want to transfer order BOM cost estimates. Order BOM cost estimates are only transferred if they were created with the same costing variant. You therefore use the same costing variant for sales order costing as for order BOM costing.

- Date control
- Quantity structure control
- If applicable, allowance for costing across company codes

You define the cost components and activate the cost component split in Customizing for *Product Cost by Sales Order* under *Preliminary Costing → Costing Sales Order Items with Product Costing*. The cost components group the costing results and determine how the costs are rolled up through the structure. If you are using a valuated sales order stock, the costs are rolled up the same way as in make-to-stock production.

If you are using Activity-Based Costing, go into Customizing for *Product Cost by Sales Order* under *Basic Settings for Product Cost by Sales Order* and make the appropriate settings for *Activity-Based Costing*.

## Transfer Control for Collective Requirements Materials

If you want to calculate the overhead for collective requirements materials differently than for individual requirements materials, then when defining the material account assignment in the *Materials Management* component you must make sure that the individual requirements materials and the collective requirements materials are assigned to different accounts and thus different primary cost elements. If you are using a valuated sales order stock, the individual and collective requirements inventories are separated by means of the valuation classes in the accounting view of the material master record.

## Features

Product costing is a tool for planning costs. It normally calculates the cost of goods manufactured of a material using the material's BOM and routing in *Production Planning*. In sales-order-related production, product costing is used to calculate the planned costs for the production of the material in the sales order item.

- For materials with nonconfigurable BOMs, the system selects the BOM and routing for the quantity structure using the quantity structure date and the quantity structure determination ID that you define in Customizing for *Product Cost Controlling*.
- For configurable materials with configurable BOMs, you define the configuration of the configured material in the sales order by selecting characteristic values (such as color or weight) for the components. The system creates the quantity structure for costing using this information and the object dependencies in the BOM and routing.

For trading goods and other materials without BOMs or routings, you can use product costing to select a price that can be different from the price according to price control (S or V) in the accounting view of the material master. This allows you to specify, for example, that for materials with V price control a planned price is used from the costing details screen in the material master record. You can calculate material overhead on the basis of this information.

The system always saves a cost component split for the product cost estimate for the sales order item. You can transfer a cost component split calculated in a sales order cost estimate to *Profitability Analysis* (CO-PA). This provides a view in CO-PA by cost components according to the sales order cost estimate.

### See also:

For more information on the required settings in Customizing, refer to the Implementation Guide (IMG) for *Product Cost Controlling*.

For information on the special features of overhead calculation in sales-order-related production, refer to the section [Overhead in Sales-Order-Related Production \[Ext.\]](#).

For information on transferring the cost component split to CO-PA, refer to the following section: [Update of Planned Costs \[Ext.\]](#)

For information on *Activity-Based Costing*, see the document *CO-ABC Activity-Based Costing*.

For information on cost component splits, refer to the document *Product Cost Planning*.

## Manually Creating a Product Cost Estimate for a Sales Order Item

### Prerequisites

You have entered the costing method *product costing* in Customizing for *Product Cost by Sales Order* in the requirements class. If you haven't entered a default costing method, you can choose the costing method directly in the sales order.

You have specified in the requirements class that costing should not be initiated automatically when the sales order is saved (*Costing* indicator) ([see also: Product Cost Estimate for Sales Order Item \[Page 102\]](#)), or you want to initiate costing manually for this particular sales order item, for example so that you can [modify it with unit costing \[Ext.\]](#).

### Procedure

1. Choose *Accounting* → *Controlling* → *Product Cost Controlling* → *Cost Object Controlling* → *Product Cost by Sales Order* → *Cost Estimate* → *Sales Order* → *Change*.

The screen *Change Sales Order: Initial Screen* appears.

2. Enter the order and choose *Enter*.
3. Select an item and choose *Extras* → *Costing*.
4. Choose the costing method *product costing*.

The following dialog boxes may appear:

- Costing variant  
Enter the costing variant for sales order costing (such as **PPC4**).  
Choose *Enter*.
- Control parameters  
Here you can:
  - Check and change the dates of the cost estimate and the dates for the BOM and routing selection
  - Check and change the parameters for transfer control

Choose *Enter*.

### Result

The system costs the sales order item.

The screen *Sales Order Costing: Costing Data for Material* appears.

You see the costing results according to cost component views (such as cost of goods sold, cost of goods manufactured).

Now proceed as follows:

1. Check the costing status. The cost estimate must have the status KA (costed without errors). Cost estimates that have errors cannot be transferred into the sales order.

**Manually Creating a Product Cost Estimate for a Sales Order Item**

2. To view the costing results by cost component, position the cursor in a view and choose *Costs* → *Display Cost Components*.

To access other reports, choose *Goto* → *Other Report*.

3. To display the costing results according to costing items, position the cursor on a view and choose *Costs* → *Itemization*.

To access other reports, choose *Goto* → *Other Report*.

4. If you want to use the sales order cost estimate to calculate the standard price of the valuated sales order stock, choose *Extras* → *Mark*.

5. Save the cost estimate.

The dialog box *Update Parameters* may appear. Specify whether an itemization is to be saved in addition to the cost component split.

6. To check the transfer of the costing results into the conditions, select the item and choose *Item* → *Conditions*.

7. Save the sales document.

If you are using a valuated sales order stock and the cost estimate has the status MARKED, the value calculated in the cost estimate is written to the stock segment of the sales order stock as the standard price if the customer exit material valuation sales order materials was not used and no goods receipt has been made.



After the first goods receipt, the standard price of materials in the sales order or project inventory can only be changed manually. If new cost estimates are created after the first goods receipt, you might not be able to tell how the price used for valuation was calculated.

If the standard price was calculated in a product cost estimate for the sales order item, you should save an itemization if:

- You want to calculate variances
- You want to calculate work in process at target costs
- You want to value the scrap

You can view the cost estimate in the sales order and in *Product Cost Controlling Information System*.

**See also:**

For information on the information system, see the document *Product Cost Controlling Information System*.

## Order BOM Cost Estimates

### Definition

Cost estimate of a BOM for a sales order item. This cost estimate is created outside the sales order. Order BOM cost estimates are supported for all individual requirements materials in the BOM structure.

Order BOM cost estimates enable materials to be costed from the bottom up during the design process in complex make-to-order production.

**See also:**

[Order BOM Cost Estimates \[Page 110\]](#)

## Order BOM Cost Estimates

### Use

Cost estimate of a BOM for a sales order item. This cost estimate is created outside the sales order. Order BOM cost estimates are supported for all individual requirements materials in the BOM structure.

Order BOM costing is recommended in complex make-to-order production. Complex structures that are gradually established over time do not have to be completely exploded to be costed. Instead, they can be costed in sections. Individual assemblies can be costed as early as the design phase, before the structure of the finished product is finalized.

Order BOM cost estimates thus enable materials to be costed from the bottom up during the design process in complex make-to-order production environments.

Order BOM costing can be used for inventory valuation of materials manufactured for sales orders. The inventory of individual material components can therefore be valued using order BOM costing even before the design of the finished product has been finalized.

Creating order BOM cost estimates and then transferring them into sales order cost estimates can significantly improve the performance of sales order costing.

Order BOM cost estimates also enable the planned costs for the sales order item to be updated in multiple valuation views. In this case you first create the sales order cost estimate. To do this, you create a maximum of two [order BOM cost estimates \[Page 109\]](#) (in addition to the sales order cost estimate) with their own costing variants for the same sales document item.

### Prerequisites

You must define the costing variant in Customizing for *Product Cost Controlling* under *Cost Object Controlling* → *Product Cost by Sales Order* → *Preliminary Costing* → *Costing Sales Order Items with Product Costing* → *Costing Variants for Product Costing* → [Check Costing Variants for Product Costing \[Ext.\]](#).



You specify in the costing variant whether you want to transfer order BOM cost estimates. Order BOM cost estimates are only transferred if they were created with the same costing variant. You therefore use the same costing variant for sales order costing as for order BOM costing.

### Features

In contrast to sales order costing, order BOM costing takes place outside the sales order. Order BOM cost estimates are created outside the sales order.

The initial material for costing can be any material below the sales order item, including the material on the sales order item. The cost estimate is created with reference to the sales order item.

When you create order BOM cost estimates for higher-level assemblies and sales order cost estimates, you can transfer cost estimates of sales-order-based assemblies. Whether order BOM cost estimates for assemblies are included in the sales order cost estimate or in an order BOM cost estimate for a higher-level assembly is controlled in Customizing in the costing variant. If you

## Order BOM Cost Estimates

have specified in the costing variant that you want to transfer order BOM cost estimates, when you create a higher-level order BOM cost estimate or sales order cost estimate the system first searches for an order BOM cost estimate before it explodes an assembly.

Transferring order BOM cost estimates can significantly improve performance when costing sales order items.

The system always updates the cost component split for the order BOM cost estimate. When you save the cost estimate, you can choose whether you also want to save the itemization. You can also specify in the costing variant whether you want the itemization to be updated. If the standard price for the valuated sales order stock is based on an order BOM cost estimate and you want to calculate variances, scrap, or work in process at target costs, make sure that an itemization exists for the cost estimate.

### Standard Price on Basis of Order BOM Cost Estimate

When you are using a valuated sales order stock, the standard price for the individual requirements material can be calculated in an order BOM cost estimate. The individual requirements material is valuated on the basis of an order BOM cost estimate in accordance with the settings in the requirements class using the strategy for standard price calculation with a valuated sales order stock. The valuation is made at the time of the first goods receipt for the material. A requirement is that the order BOM cost estimate is marked. You mark the cost estimate when you create the order BOM cost estimate. **The semifinished products in the multilevel BOM for a sales order item can be valuated even before the structure of the finished product is finalized.**

### Purpose of Sales Order Costing

If you have created an order BOM cost estimate for the finished product in the sales order item, you should still create a [product cost estimate for the sales order item \[Page 102\]](#). When a [sales order cost estimate \[Page 95\]](#) is created, this has the following effects:

- The status of the sales order item is updated: The status of the sales order item is set to *Cstd* (costed).
- The conditions are updated in SD.
- The planned costs are updated to the sales order item.

These functions are **not** performed through an order BOM cost estimate.

### Constraints

A costing run for multiple order BOM cost estimates that are not linked to each other is **not** supported.

If a subordinate assembly in a multilevel BOM for a sales order item is changed and costed, this has no effect on the cost estimate of the higher-level assembly. If you change assemblies, you must take organizational steps to ensure that all relevant cost estimates are organized.

### User-Defined Error Management

You can influence the messages output in the log of order BOM costing by using [user-defined error management \[Ext.\]](#).

#### See also:

For information on standard price calculation with valuated sales order inventories, see the following section:

**Order BOM Cost Estimates**

[Standard Price with Valuated Sales Order Stock \[Ext.\]](#)

For information on updating costing data, refer to the following section:

[Update of Planned Costs \[Ext.\]](#)

For information on updating data in multiple valuation views, refer to the following section:

[Transfer Prices in Cost Object Controlling \[Ext.\]](#)



## Creating and Marking an Order BOM Cost Estimate

### Prerequisites

Define the costing variant in Customizing for *Product Cost Controlling*. You can specify in the costing variant whether you want the itemization to be saved.

### Procedure

1. Choose *Accounting* → *Controlling* → *Product Cost Controlling* → *Cost Object Controlling* → *Product Cost by Sales Order* → *Costing* → *Order BOM* → *Create*.

The screen *Create Cost Estimate for Order BOM* appears.

2. Enter the following data:
  - Number of the SD document and the item
  - Also enter the costing variant, material, plant, and costing lot size (if applicable)



The costing variant, material, plant, and costing lot size can also be:

- Entered manually
- Transferred from the sales order item This data is transferred from the sales order item if the data has been entered in the sales order item and you do not enter any data manually here.

3. Choose *Enter*.

The system transfers the control parameters (costing dates and transfer control) from the costing variant, and costs the order BOM.

### Result

The system always updates a cost component split for the order BOM cost estimate. When you save the cost estimate, you can choose whether you also want to save the itemization.

You can display the following on an order BOM cost estimate:

- A list of the costed materials
- A list of the costing levels

The costing level controls the sequence in which the materials are costed. The costing level is issued internally by the system and is inverse to the low-level code. The costing level enables cost rollup over more than one manufacturing level.

- Another cost component view

If you want to calculate the **standard price** for the sales order material on the basis of the order BOM cost estimate, mark the order BOM cost estimate. Do this by choosing *Extras* → *Mark*. The system assigns the status VO (marked) to the cost estimate.

To view the cost estimate at a later time, access the *Product Cost by Sales Order* menu and choose *Master Data/Planning* → *Cost Estimate for Order BOM* → *Display* and enter the required data. Then choose *Enter*.

**Creating and Marking an Order BOM Cost Estimate**

**See also:**

[Standard Price with Valuated Sales Order Stock \[Ext.\]](#)

## Blocking Requirements

### Use

You can block the generation of requirements until the processing of order BOMs is completed. In this way, you can prevent the system from generating requirements during the planning run, for assemblies that are still to be post-processed in the design.

### Features

You can stop the generation of requirements on different levels:

- in the **schedule line category** in the sales order item

A requirement generation is stopped by some schedule line categories, for example, in the standard system, by the schedule line category CN. At the time when you want to generate requirements, set the schedule line category CP for example. This schedule line category allows the generation of requirements in the standard system.

In Customizing SD you define, for specific combinations of item categories and MRP types:

- Which schedule line category the system recommends as standard.
- Which schedule line categories can be set manually.

In Customizing SD choose *Sales* → *Sales document* → *Schedule lines* → *Assign schedule line categories*.

- for configurable BOMs, you can stop it in the **configuration status** in variant configuration

**See also:**

[Transfer of requirements using blocked configuration \[Ext.\]](#)

- In the **BOM status**

You define the status of a BOM in Customizing BOMs, by choosing *General Data* → [Define BOM status \[Ext.\]](#).

You set the status of a BOM in the detail screen of the [BOM header \[Ext.\]](#).

## Order BOMs in MRP

## Order BOMs in MRP

### Use

MRP ensures that materials are available, which means that the required quantities are procured in due time.

MRP for order BOMs is basically the same as standard MRP. Merely the following prerequisites must be met.



You can use the Project System for MRP. See [Advance Procurement \[Ext.\]](#) and [Material Requirements Planning in BOM Transfer \[Ext.\]](#) for further information.

### Prerequisites

- You have activated BOM explosion for sales order BOMs in the “*Define BOM Explosion Control*” activity in Customizing for MRP.
- You have released the requirements for MRP (see also: [Blocking Requirements \[Page 115\]](#)).
- You have selected a strategy group in the material master that allows make-to-order production for the material in the sales order item.
- You have set the *Individual/coll.* indicator to *Individual and collective requirements* or *Individual requirements only* in the material master (*MRP 4* view) for each header material in an order BOM. You have made the same settings for all assemblies that are on a higher level on a direct path above the order BOM.



The system always selects the material BOM in MRP when only collective requirements are allowed for an assembly. The material BOM is also selected when only collective requirements are allowed for an assembly that is on a higher level on a direct path.

You can use the [explosion types \[Ext.\]](#) (*basic data* tab page on the item detail screen) in the BOM to override the setting in the material master record (*MRP 4* view).

Select an explosion type that allows either *collective and individual requirements* or *individual requirements only* on the item detail screen for the components in the higher-level BOM when you want to fix the BOM for a material and the setting for the BOM is *collective requirements only*. The setting in the BOM item overrides the setting in the material master record.

### Features

There is an MRP run for make-to-order production. This planning run does the following with reference to the sales order item:

- It determines the net requirements
- It calculates the procurement quantities
- It determines dates

## Order BOMs in MRP

- It determines procurement elements
- It explodes the multi-level BOM for the sales order item

You can check the planning result in the MRP list or the stock/requirements list.

A special case is when you work with detached order assemblies that you want to plan and manufacture before they are integrated in a multi-level BOM for a sales order item.

For further information on MRP, see *PP – Material Requirements Planning*, under

[Control Parameters for the Planning Run \[Ext.\]](#)

[Multi-Level, Make-to-Order Production \[Ext.\]](#)

[MRP List and Stock/Requirements List \[Ext.\]](#)

## Plan Material Requirements for Detached Order Assemblies

## Plan Material Requirements for Detached Order Assemblies

### Use

This procedure describes how to handle [detached order assemblies \[Page 23\]](#) in MRP: You can plan and manufacture them but still change the multi-level BOM for the sales order item. You can settle the quantity of assemblies already produced against the quantities still to be produced when you integrate the order assembly in the BOM at a later date and you have finished creating the BOM.

### Prerequisites

- You have created a sales order and a sales order item.
- You have created a detached order assembly with an order BOM for the sales order item.







You can also use any assembly with a material BOM, which means without an order BOM, as a detached order assembly. The system runs MRP correctly for this assembly but the assembly is not displayed in the order browser. This means that Engineering and Design cannot use the assembly for changes to the BOM.

- You have selected the strategy group *Planning at assembly level* (strategy 70 in the standard SAP System) in the material master for the header material of the order assembly. You have also set the *mixed MRP indicator*, selected a *consumption mode*, and entered a *consumption period*.

For further information on this planning strategy, see [Planning at Assembly Level \(70\) \[Ext.\]](#) in Demand Management (PP-MP-DEM).

### Procedure

1. Starting from the Demand Management node, choose *Planned Independent Requirement* → *Create*. Enter the material number for the header material of the order assembly and the plant or the MRP area. Click .
2. Enter the planned independent requirement.
3. Assign the account for the planned independent requirement to the sales order and the sales order item:
  - a. Choose *Goto* → *Additional data*.  
The *Indep. Reqmts: Additional Data* dialog box appears.
  - b. Select category E, *customer individual requirement*, as the *account assignment category*. Click  and enter the number of the sales order and the sales order item. Click  and .

You can use  next to the *Acct. assmt cat.* field in the *Indep. Reqmts: Additional Data* dialog box to check the account assignment data at any time.

### Plan Material Requirements for Detached Order Assemblies

The accounts for the planned independent requirements for the order assembly are now assigned to the sales order. These planned independent requirements can be settled against the dependent requirements for the sales order when the assembly is integrated in the multi-level BOM for the sales order item.

4. Starting from the MRP node, choose *Planning* → *Single-Item, Multi-Level*. Enter the material number for the header material of the order assembly and the MRP and process parameters. Click  twice.

The system uses the account assignment to the sales order item and thus selects and explodes the order BOM for this material, when there is one. The system displays the runtime statistics for the planning run.

5. Starting from the MRP node, choose *Evaluations* → *Stock/Reqmts List*. The header material for the order assembly is the default material number. Click  twice.

The system displays the stock/requirements list for the material. The MRP elements are displayed in a separate individual customer segment.

## Result

The system has generated planned independent requirements on assembly level (requirements type VSFB) for the header material of the detached order assembly. The system has assigned the accounts to the sales order item for the sales order. The system then generated planned orders or purchase requisitions to cover these planned independent requirements in the MRP run.

You can convert the planned orders to production orders and the purchase requisitions to purchase orders, thus triggering production and external procurement for this order assembly.

## Plan Material Requirements for Sales Order Items

# Plan Material Requirements for Sales Order Items

## Use

This procedure describes how you plan material requirements for sales order items when the multi-level BOM for the sales order is finished. It also describes how you then handle order assemblies that have already been planned or have already been manufactured.

## Prerequisites

- You have created a sales order and a sales order item.
- You have planned material requirements for [detached order assemblies \[Page 23\]](#) when necessary, as described in [Plan Material Requirements for Detached Order Assemblies \[Page 118\]](#).
- You have created a multi-level BOM for the sales order item and integrated any necessary detached order assemblies in the BOM structure.

## Procedure

1. Starting from the MRP node, choose *Planning* → *Single-Item, Sales Order*. Enter the number of the sales order and the sales order item as well as the MRP and process parameters. Click  twice.

The system explodes the multi-level BOM for the sales order item from the lowest level to the highest level and plans all the materials. The system displays the runtime statistics for the planning run.
2. Starting from the MRP node, choose *Evaluations* → *Stock/Reqmts List*. The material for the sales order item is the default material number. Click  twice.

The system displays the stock/requirements list for the material. The MRP elements are displayed in a separate individual customer segment.
3. Choose *Show overview tree*.

The overview tree is displayed on the left of the screen. Only the material for the sales order item is displayed in the tree.
4. Click  to access the order tree for the first procurement element.

All the materials that the system planned when it exploded the BOM are displayed hierarchically in the order tree.
5. Double-click a material that was the header material for a detached order assembly. Check the stock/requirements situation for the material.

## Result

The system has planned all levels of the multi-level BOM for the sales order item. At the same time, it has settled any planned independent requirements from assembly planning against the dependent requirements that were transferred from top to bottom in the planning run.



## Order BOMs in Production

### Use

The automatically use order BOMs in production if you create a production order with reference to a sales order with an order BOM. In this case, during the transfer of master data to the production order, the order BOM is chosen as a matter of priority. Since there can only be one order BOM per material and sales order, no selection mechanisms are required, as they are for the selection of material BOMs (see [Selecting a bill of material \[Ext.\]](#)).



If you, as a make-to-order manufacturer, want to monitor the production order links over several levels, you may also be interested in direct production with collective orders (see [Collective order \[Ext.\]](#)).

### Integration

Changes to an order BOM are treated as master data changes, in the context of order change management for production orders (OCM) (see [Order change management for production orders \[Ext.\]](#), [Creation of initiating objects \[Ext.\]](#)).

### Features

The transfer of an order BOM into a production order takes place without any special preparation being necessary in production control. The transfer takes place by carrying out the following actions:

- [Planned order conversion \[Ext.\]](#)

The conversion of planned orders into production orders can be carried out as [individual conversion \[Ext.\]](#), [collective conversion \[Ext.\]](#) and [partial conversion \[Ext.\]](#). If the components have been fixed in the planned order, they are transferred from the planned order and no transfers of the order BOM into the production order take place.
- [Creating a production order with a sales order \[Ext.\]](#)

You can create production orders (avoiding requirements planning) with direct reference to a sales order.
- [Reading master data \[Ext.\]](#)

If an order BOM exists it is transferred to the production order when the master data is read.



From the initial screen of the [order browser \[Page 176\]](#) you can call up the [order progress report \[Ext.\]](#) (see [Calling up the order progress report \[Ext.\]](#)).

## Enhancements to the SAP Systems in the Area of PLM

## Enhancements to the SAP Systems in the Area of PLM

### Purpose

You can optimize your work processes in the area of [Product Lifecycle Management \[Ext.\]](#) (PLM) by changing and enhancing the scope of functions the standard SAP System. The enhancements are part of the standard SAP System and can be set up in your SAP System by means of enterprise-specific logic.

### Enhancements

The following is an overview of the supported enhancements in the area of PDM.

Enhancement	Note
<p><b>Customer exit</b></p> <p><b>See also:</b> <a href="#">Customer Exits [Ext.]</a></p>	<p><b>Use</b></p> <p>The function process of the standard SAP System is done by means of customer exit within the SAP System enhancement concept. The exits provided with the system do not have any functionality of their own. They simply represent a starting point for additional document distribution functions which you can develop using company-specific logic.</p> <p><b>Integration</b></p> <p>The customer exits are programmed as function module exits. You create an enhancement project by editing an enhancement that SAP has supplied. The enhancement contains the function module for the required function. The function module leads to an include program where you encode the enterprise-specific function requirements.</p> <p><b>Prerequisites</b></p> <p>When you use a function exit, you must create a company-specific include program that matches the programming logic of the function module. For example, the data that can be transferred from the include program to the standard program, and vice versa, is predefined here. Since each call for a customer-specific function module used contains both export and import parameters, the customer-specific function modules are also equipped with this predefined interface.</p>

**Enhancements to the SAP Systems in the Area of PLM**

<p><a href="#">Business Add-In [Ext.]</a></p>	<p><b>Use</b></p> <p>Business Add-Ins are defined parts within a source that can add coding for different software levels, such as branches, partners, or customers, without changing the original program itself. The coding of the standard SAP System allows you to add implementation where the methods for the enterprise-specific processing are set.</p> <p><b>Integration</b></p> <p>The coding of the standard SAP System contains the definitions of the interfaces as well as the calls for the application programs. This enhancement is made of an interface and a method.</p> <p>Each Business Add-in is made up of various methods that can be called in preset processing situations. The methods set the operations for the documents or their original application files. The enterprise-specific coding is entered in <i>Implementation</i>.</p> <p><b>Prerequisites</b></p> <p>You must enter the enterprise-specific enhancements in an implementation. You must create an implementation for the Business Add-In you have chosen and enter the required coding for the method. After the implementation is active you can use it when executing the application program.</p>
<p>Business Transaction Events</p> <p><b>See also:</b></p> <p><a href="#">Using Business Transaction Events [Ext.]</a></p>	<p>You can use two types of interfaces for modifying and enhancing the standard SAP System:</p> <ul style="list-style-type: none"> <li>• Publish &amp; Subscribe interface (informative interfaces) The interface informs that a particular result has been produced and transfers the data to external software.</li> <li>• Process interface (Process) This interface replaces the standard processes from the SAP System.</li> </ul>
<p><b>User exits in Customizing</b></p>	<p>You determine in Customizing of the application which enterprise-specific changes you want to carry out. You will find detailed notes in the IMG.</p>



Use the ABAP Workbench for the customer exits as well as for business add ins. Modification to SAP sources and ABAP Dictionary Objects are done within SAP Software Change Registration (SSCR).

These changes are upward compatible. This means that they remain effective even after an upgrade or installation of a support package.

**Enhancements for Objects from the Area of PDM**

The following overview shows which enhancements are supported for which SAP objects.

SAP Object	Customer exit	Business Add-In	Business Transaction Events	User Exits

## Enhancements to the SAP Systems in the Area of PLM

<a href="#">Document [Page 125]</a>	X	X		X
<a href="#">Material [Page 158]</a>	X		X	
<a href="#">Change master record [Page 160]</a>	X			
<a href="#">Bills of Material [Page 162]</a>	X		X	

## Enhancements in Document Management

### Use

You can set up work processes in the area of *Document Management* with different enhancements at an enterprise level.



Information about enhancements as well as an overview of planned enhancements to SAP objects in the area of PDM-can be found in [Enhancements to the SAP System in the Area of PDM \[Page 122\]](#).

### Features

The following overview shows which enhancements are supported in the standard SAP System in the area of DMS.

Enhancement	Use
<a href="#">Enhancements using Customer Exits [Page 126]</a> <b>See also:</b> <a href="#">Customer exit [Ext.]</a>	You can set up Document <i>distribution</i> using customer exits in an enterprise-specific way.
<a href="#">Enhancements using Business Add-Ins [Page 143]</a> <b>See also:</b> <a href="#">Business Add-In [Ext.]</a>	The coding of the standard SAP System allows you to add more than one implementation where the methods for the enterprise-specific processing of document info record and original application files are set.
<a href="#">Enhancements using User Exits in Customizing [Page 156]</a>	You determine in Customizing of the Document Management which enterprise-specific changes you want to carry out. You will find detailed notes in the IMG.

## Enhancements using Customer Exits (Document)

## Enhancements using Customer Exits (Document)

### Use

In order to optimize the business processes in document management you can change some functions of the SAP System by using [Customer Exits \[Ext.\]](#). You can, for example, add additional authorization checks.

#### See also:

[Enhancements of the SAP System in the Area of PDM \[Page 122\]](#) and [The SAP System Enhancement Concept \[Ext.\]](#)

### Prerequisites

When you use a function exit, you must create a company-specific include program that matches the programming logic of the function module.



You want to determine the original application files for a distribution order. You create an enhancement project where you use the enhancement CVDI0003 (*Determine original application files*). The enhancement contains the function module for the required function (for example, EXIT\_SAPLCVV1\_003). The function module branches to the include program zxcvv5u02. You use this include program to program your specific functional requirements.

### Features

The tables below show the enhancements for customer exits used in document distribution (development class CVDI).

#### Enhancements for Function Group XCVV1 (Recipient List)

Use	Enhancement	Function Module
Save recipient list	CVDI0001	<a href="#">EXIT_SAPLCVV1_001 [Page 128]</a>
Modify initial values for screen 100	CVDI0002	<a href="#">EXIT_SAPLCVV1_002 [Page 130]</a>
Determine original application file	CVDI0003	<a href="#">EXIT_SAPLCVV1_003 [Page 133]</a>
Determine document part and version of a document	CVDI0004	<a href="#">EXIT_SAPLCVV1_004 [Page 135]</a>
Create distribution order	CVDI0005	EXIT_SAPLCVV2_001

#### Enhancements for Function Group XCVV2 (Distribution Order)

Use	Enhancement	Function Module
Create distribution order	CVDI0005	<a href="#">EXIT_SAPLCVV2_001 [Page 135]</a>

**Enhancements using Customer Exits (Document)**

Check part order	CVDI0006	<a href="#">EXIT_SAPLCVV2_002 [Page 136]</a>
Create initial order	CVDI0007	<a href="#">EXIT_SAPLCVV2_003 [Page 137]</a>

**Enhancements for Function Group XCVV5 (Events)**

Use	Enhancement	Function Module
Determine context	CVDI0008	<a href="#">EXIT_SAPLCVV5_001 [Page 139]</a>

**Enhancements for Function Group XCVVW (ITS Access)**

Use	Enhancement	Function Module
ITS access	CVDI0009	<a href="#">EXIT_SAPLCVVW_001 [Page 141]</a>

## Finding Recipient Lists (EXIT\_SAPLCVV1\_001)

## Finding Recipient Lists (EXIT\_SAPLCVV1\_001)

### Definition

Function module that is called by customer exit CVDI0001 when a recipient list is saved and **before** the data is written to the database.

### Use

You cannot change the program logic. You can only change the data in the logic.

### Structure

The interface is structured as follows:

#### Parameters that can be processed in the Function Module

	Parameter	Parameter value Result	Direction	Description
importing	i_action	I	→	Create a recipient list
		U	→	Change a recipient list
exporting	e_return	0	←	OK
		<>0	←	Error
changing	c_drzao		↔	As database structure DRZAO (general data in a recipient list)

#### Tables Whose Fields can be Processed in the Function Module

Table	Description
T_DRZA	As database structure CVIDRZA (recipient-document relations)
T_DRZAT	As database structure CVIDRZAT (language-dependent description)

### Integration

You can enter your company-specific programming logic in the source code of include program zxcvv1u01.



## Screen: Basic Data for Maintaining Documents

### Definition

Function module that is called by customer exit CV110001.

### Use

You can add to and enhancement the dialog for maintaining document data (function module in development class CV, function group CV110).

### Integration

You can enter your company-specific programming logic in the source code of include program ZXC110U01.

Screen: Recipient Lists (EXIT\_SAPLCVV1\_002)

## Screen: Recipient Lists (EXIT\_SAPLCVV1\_002)

### Definition

Function module that is called by customer exit CVDI0002 **after** the data for recipient list screen (screen 100, program `SAPLCVV1`) has been read.

### Use

Depending on the function (`i_function`) called, documents, recipients, or general data is determined. You can change this data in the include program. The modified data is then displayed on screen 100 (program `SAPLCVV1`).

If you change recipient data, for example, the changes must also be made in the following tables:

- Table T\_DRZA (document recipient relation)
- Table T\_REC (to display the change in the table control)

### Structure

The interface is structured as follows:

#### Parameters that can be processed in the Function Module

	Parameter	Parameter value	Direction	Description
exporting	e_return	0 <>0	←	OK Error

Screen: Recipient Lists (EXIT\_SAPLCVV1\_002)

importing	i_function	CR	→	Create recipient list
		CH		Change recipient list
		DI		Display recipient list
		RD		Display all recipients of a document
		DR		Display all documents sent to a recipient
		SC		Display
		SW		Start distribution with Recipient Lists
		SN		Start distribution with dialog
		SR		Start distribution without dialog
		ST		Start distribution without reading existing recipient list
		RE		Start distribution with standard recipient list
		RP		Restart distribution with dialog
				Restart distribution of a package with dialog
				Number of the recipient list
	Number of the template for Recipient Lists			
	i_ass_id			
	i_ref_ass_id			

Tables Whose Fields can be Processed in the Function Module

Table	Description
T_DRZA	As database structure CVIDRZA (document/recipient relation)
T_DOC	As database structure CVIDOC_TAB (documents displayed in the table control)
T_REC	As database structure CVIREC_TAB (recipients displayed in the table control)
T_IMP_OBJ	As database structure CVDIOBJ (table with selected document that was used to start the function)

---

**Screen: Recipient Lists (EXIT\_SAPLCVV1\_002)**

T_TEXT	As database structure CVITEXT (language-dependent description of the recipient list) - for recipient list functions only
--------	--

## Integration

You can enter your company-specific programming logic in the source code of include program zxcvv1u02.

## Determine Original Application File (EXIT\_SAPLCVV1\_003)

### Definition

Function module that is called by customer exit CVDI0003 to determine the original application file that is to be sent.

### Use

If the file is to be distributed manually (in dialog mode), this value is a default value and can be overwritten.

### Structure

The interface is structured as follows:

#### Parameters that can be processed in the Function Module

	Parameter	Parameter value	Direction	Description
exporting	e_return	0 <>0	←	OK Error



## Document Part and Version (EXIT\_SAPLCVV1\_004)

### Definition

Function module that is called by customer exit CVDI0004. This function module is used to determine the key fields “document part” and “version” for the document to be distributed.

The customer exit is called when distribution is started for the recipient list (transaction CV17).

### Use

The last version released is determined and proposed as a default for all documents in the recipient list. To determine a different version, enter your own logic for determining the version in the include.

### Structure

The interface is structured as follows:

#### Parameters that can be processed in the Function Module

	Parameter	Parameter value Result	Direction	Description
importing	e_doktl e_dokvr e_return	0 <>0	→	Document part Document version OK Error
exporting	i_doknr i_dokar		←	Document number Document Type

### Integration

You can enter your company-specific programming logic in the source code of include program zxcvv1u04.

## Create Distribution Order (EXIT\_SAPLCVV2\_001)

## Create Distribution Order (EXIT\_SAPLCVV2\_001)

### Definition

Function module that is called by customer exit CVDI0005.

This customer exit is checked in the `create` method of BOR object BUS1082 (function module CVV2\_DDO\_CREATE – create distribution order). The exit is called after an initial order has been created and the INITIATED event has been generated.

### Use

The distribution order parameters can be modified in the include. Individual part orders that are not relevant for distribution can be deleted from the table. Status *IG* or *ER* must be set in the customer exit for these part orders. You can use function module CVV3\_DDOC\_SET\_READY (set part order status) for this purpose.

### Structure

The interface is structured as follows:

#### Parameters that can be processed in the Function Module

	Parameter	Parameter value	Direction	Description
exporting	e_return	0 <>0	←	OK Error
changing	c_drzo		↔	As database structure DRZO (distribution order data)

#### Tables Whose Fields can be Processed in the Function Module

Table	Description
T_DDOC	List of part order numbers (structure: CVIORDERCOMP)

### Integration

You can enter your company-specific programming logic in the source code of include program zxcvv2u01.



## Check Part Order (EXIT\_SAPLCVV2\_002)

### Definition

Function module that is called by customer exit CVDI0006.

This customer exit is checked in the `check` method of BOR object BUS1082 (function module CVV2\_DDO\_CHECK – check distribution order). The exit is called after an initial order has been created and the INITIATED event has been generated.

### Use

The status of the part order is set to ER (error) if the `e_return` parameter returns a value  $\neq 0$ . A special process is implemented in the workflow for part orders that contain errors.

### Structure

The interface is structured as follows:

#### Parameters that can be processed in the Function Module

	Parameter	Parameter value	Direction	Description
exporting	e_return	0 <>0	←	OK Order part has errors, do not distribute
importing	ddoc_id		→	Part order number

### Integration

You can enter your company-specific programming logic in the source code of include program `zxcvv2u02`.

## Create Initial Order (EXIT\_SAPLCVV2\_003)

## Create Initial Order (EXIT\_SAPLCVV2\_003)

### Definition

Function module that is called by customer exit CVDI0007 when the system creates an initial order.

### Use

The initial order data and part order data can be modified. You can also specify a status to be set for the part orders. If an error occurs in this customer exit, it must be output with the following statement: `MASSEGE ID id TYPE mtype NUMBER n raising ERROR.`

### Structure

The interface is structured as follows:

#### Tables whose Data can be Changed (Changing)

changing	Description
c_drzoi	Initial order data (structure DRZOI)
c_status	Status SY - start immediately AS - start in the background MA - start manually in distribution log

#### Tables Whose Fields can be Processed in the Function Module

Table	Description
T_DRZOC	Part orders (structure: DRZOC)

#### Interface Parameters for Exceptions

Parameter	Description
ERROR	Error situation

### Integration

You can enter your company-specific programming logic in the source code of include program `zxcvv2u03`.

## Determine Context (EXIT\_SAPLCVV5\_001)

### Definition

Function module that is called by customer exit CVDI008 if distribution is started by an event.

### Use

The context that is to be used for distribution can be determined here. You can specify a context for an event in Customizing for Document Distribution. If other contexts are also to be included for this event, you must use this customer exit.

The function module is called in the following function modules:

- CVV5\_EVENT\_START\_DISTRIBUTION (start distribution – initiated by an event)
- CVV5\_EVENT\_START\_DIST\_ECM (start distribution when change master record event is released)

### Structure

The interface is structured as follows:

#### Parameters that can be processed in the Function Module

	Parameter	Parameter value	Direction	Description
exporting	e_return	0 <>0	←	OK Error
importing	i_event  i_objkey  l_objtype		→	Event (such as SWEINSTOU-EVENT) Object key (such as SWEINSTOU-OBJKEY) Object type (such as SWEINSTOU-OBJTYPE)
changing	c_context			Context

#### Tables Whose Fields can be Processed in the Function Module

Table	Description
T_EVENT_CONTAINER	Event container (structure SWCONT)

---

Determine Context (EXIT\_SAPLCVV5\_001)

## Integration

You can enter your company-specific programming logic in the source code of include program zxcvv5u02.

## ITS Access (EXIT\_SAPLCVVW\_001)

### Definition

Function module that is called by customer exit CVDI0009 if the original application file is to be accessed via the Internet Application Server (ITS).

### Use

Additional authorizations, for example, can be checked in this customer exit.

The exit is called in function module CVVW\_GET\_ORIGINAL (read original application file from application server).

### Structure

The interface is structured as follows:

#### Parameters that can be processed in the Function Module

	Parameter	Direction	Description
importing	e_doknr	→	Document number
	i_dokar		Document Type
	i_doktl		Document part
	i_dokvr		Document version
	i_filename		File name on application server
	i_ddoc_id		Part order number
	i_application		Workstation application

#### Interface Parameters for Exceptions

Parameter	Description
ERROR	Error situation

### Integration

You can enter your company-specific programming logic in the source code of include program zxcvvwu01.

---

Determining the Application (EXIT\_SAPLCVV1\_005)

## Determining the Application (EXIT\_SAPLCVV1\_005)

### Definition

Function module that is called by customer exit CVDI0010.

### Use

You can determine which workstation application was used to process the original application files that are to be distributed with this function module.

## Enhancements using Business Add-Ins (Document)

### Use

In order to optimize processes in your enterprise when working with document processing you can use Business Add-Ins to enhance the processing functions of the standard system.

**See also:**

[Enhancements of the SAP System in the Area of PDM \[Page 122\]](#) and [Business Add-Ins \[Ext.\]](#)

### Integration

The coding of the standard SAP System contains the definitions of the interfaces as well as the calls for the application programs. This enhancement is made of an interface and a method.



You can use a Business Add-In to set that when a workstation application is started that compressed original application files are reproduced.

### Prerequisites

You must create an implementation for the Business Add-In you have chosen and enter the required coding for the method.

### Features

The following overview shows the Business Add-Ins that are supported in the Document Management System (development class CV).

#### Business Add-Ins for the Document Management System

Description	Business Add-In
Checking Authorization from the Document Management Systems	<a href="#">DOCUMENT_AUTH01 [Page 145]</a>
Processing of Original Application Files	<a href="#">DOCUMENT_FILES01 [Page 146]</a>
General document processing	<a href="#">DOCUMENT_MAIN01 [Page 148]</a>
Status checks	<a href="#">DOCUMENT_STATUS01 [Page 150]</a>
Transport of Original Application Files	<a href="#">DOCUMENT_STORAGE01 [Page 151]</a>

#### Business Add-In without the Documentation in the SAP Library

The following Business Add-Ins were added to the notes 02200177:

Description	Business Add-In
Document exits and Menu enhancements for PAI in CV01N, CV02N, CV03N	DOCUMENT_MAN02
Enhanced number checks	DOCUMENT_NUMBER01
Filter for DMS processes	DOCUMENT_PROC01

**Enhancements using Business Add-Ins (Document)**

Enhancements for the DMS@Web scenarios	DOCUMENT_WEB01
Enhancements for Microsoft Office integration	DOCUMENT_OFFINTEGR01



## Checking Authorization from the Document Management Systems

### Definition

Interface for an enhancement that the customer can use to extend the authorization check of the standard SAP System to include enterprise-specific authorization checks.

### Use

You program the enterprise-specific authorization checks for the method of the Business Add-In.

### Structure

The interface of the Business Add-In includes the following method:

Method	Call	Example of a special check
CHECK_AUTHORITY	After checking the authorization of the following authorization objects: C_DRAW_TCD C_DRAW_TCS C_DRAW_DOK	Enterprise-specific logic when deleting

### Integration

You implement the enhancement by using Business Add-In DOCUMENT\_AUTH01.

## Processing of Original Application Files

## Processing of Original Application Files

### Definition

Interface for an extension where the customer's enterprise-specific requirements for processing original application files are implemented.

### Use

You can use one or more methods for implementing the interface. You program the enterprise-specific requirements for the method of the Business Add-In.

### Structure

The interface of the Business Add-In includes the following method:

Method	Call	Example of a special check
BEFORE_ASSIGN_FILE	Before the assignment of a physical file (original application file)	<ul style="list-style-type: none"> <li>Automatic definition of an original application file</li> <li>Enterprise-specific checks</li> </ul>
AFTER_ASSIGN_FILE	After the assignment of a physical file (original application file)	Check whether the original application file is valid
BEFORE_START_APPL	Before starting the application	Reproduces compressed files
AFTER_START_APPL	After starting the application	Deletion of temporary files
BEFORE_COPY_FILE_DIALOG	When you create a new version and when the original application files are not checked in before the dialog box for entering a copy path is displayed	Automatic determination of the file name of the new version
AFTER_COPY_FILE_DIALOG	When you create a new version and when the are not checked in after the original application files were copied	Check whether an original application file exists
GENERATE_COPY_FILE_NAME	When you create a new version and when the are not checked in and before the standard process for generating file names is run	Enterprise-specific name conventions for original application files when creating a new version

### Integration

You implement the enhancement by using Business Add-In DOCUMENT\_FILES01.

---

Processing of Original Application Files

Used more than once? If yes, where?

## General Document Processing

## General Document Processing

### Definition

Interface for an extension where the customer's enterprise-specific requirements for processing documents are implemented.

### Use

You can use one or more methods for implementing the interface. You program the enterprise-specific requirements for the method of the Business Add-In.

### Structure

The interface of the Business Add-In includes the following method:

Method	Call	Example of a special check
BEFORE_READ_DATA	After the main screen <i>Create, Change, Display</i> and before reading the data	<ul style="list-style-type: none"> <li>Number check</li> <li>Version determination</li> <li>Company authorization check</li> </ul>
AFTER_READ_DATA	After the main screen <i>Create, Change, Display</i> and before reading the data	<ul style="list-style-type: none"> <li>Set the default values</li> <li>Change data</li> </ul>
ASSIGN_NUMBER	When saving	Number determination (instead of routine GET_NUMBER in program MCDOKZNR)
BEFORE_SAVE	Before saving the document but after calling the internal number assignment	Check the data
BEFORE_DELETE	Before setting the deletion indicator	Enterprise-specific logic when deleting
AFTER_SAVE	After saving the document data	Enterprise-specific logic after saving
AFTER_DETERMINE_VALID_VERSION	After determining the valid version	Enterprise-specific determination of the valid versions

### Integration

You implement the enhancement by using Business Add-In DOCUMENT\_MAIN01.

Used more than once? If yes, where?

## General Document Processing (II)

### Definition

Interface for an enhancement you can use to check menu enhancements at the PAI time point.

These checks take place in the following processing situations:

- Create document (CV01N)
- Change document (CV02N)
- Display document (CV03N)

### Use

You can use one or more methods for implementing the interface. You program the enterprise-specific requirements for the method of the Business Add-In.

### Structure

The interface of the Business Add-In includes the following method:

Method	Call	Example of a special check
D100_BEFORE_PAI	Before the actual PAI of the <a href="#">screen [Ext.] 100</a>	Enterprise-specific checks when selecting a function in DMS
D101_BEFORE_PAI	Before the actual PAI of the screen 101	Enterprise-specific checks when selecting a function in DMS
D100_PAI_CU1	PAI for menu enhancement 1 (+D100_CU1) screen 100	Menu enhancement for the initial screen of document processing
D100_PAI_CU2	PAI for menu enhancement 1 (+D100_CU1) screen 100	Menu enhancement for the initial screen of document processing
D100_PAI_CU3	PAI for menu enhancement 1 (+D100_CU1) screen 100	Menu enhancement for the initial screen of document processing
D101_PAI_CU1	PAI for menu enhancement 1 (+D100_CU1) screen 101	Menu enhancement for the initial screen of document processing
D101_PAI_CU2	PAI for menu enhancement 1 (+D100_CU1) screen 101	Menu enhancement for the initial screen of document processing
D101_PAI_CU3	PAI for menu enhancement 1 (+D100_CU1) screen 101	Menu enhancement for the initial screen of document processing

### Integration

You implement the enhancement by using Business Add-In DOCUMENT\_MAIN02.

## Status checks

# Status checks

## Definition

Interface for an extension where the customer's enterprise-specific requirements for status check are implemented.

## Use

You can use one or more methods for implementing the interface. You program the enterprise-specific requirements for the method of the Business Add-In.

## Structure

The interface of the Business Add-In includes the following method:

Method	Call	Example of a special check
AFTER_CHANGE_STATUS	After every status change according to the status checks of the standard system	Status dependent enterprise-specific checks
BEFORE_LIST_STATUS	Before the list of possible statuses is displayed	Restriction of the list of possible statuses for the selected status check

## Integration

You implement the enhancement by using Business Add-In DOCUMENT\_STATUS01.

## Transport of Original Application Files

### Definition

Interface for an extension where the customer's enterprise-specific requirements for transport of original application files are implemented.

### Use

You can use one or more methods for implementing the interface. You program the enterprise-specific requirements for the method of the Business Add-In.

### Structure

The interface of the Business Add-In includes the following method:

Method	Call	Example of a special check
BEFORE_CHECKIN	Before physically transporting the original application file (Check-in)	<ul style="list-style-type: none"> <li>Compress original application file</li> <li>Specify storage area</li> </ul>
AFTER_CHECKIN	After physically transporting the original application file (Check-in)	<ul style="list-style-type: none"> <li>Delete original application file on the frontend computer</li> <li>Set status</li> </ul>
BEFORE_CHECKOUT	<p>Before physically transporting the original application file (Check-out) create when displaying, changing, printing or copying</p> <p>The call also is possible for original application files that are not checked in.</p>	<ul style="list-style-type: none"> <li>Convert file name</li> <li>Set path for additional files</li> </ul>
BEFORE_LIST_STORAGECAT	Before displaying the possible storage categories	Application-specific filter for the list of possible storage categories

### Integration

You implement the enhancement by using Business Add-In DOCUMENT\_STORAGE01.

## Checking the Attributes of the Document Key

# Checking the Attributes of the Document Key

## Definition

Interface for an enhancement you can use to check enterprise-specific requirements you made in attributes.

The following attributes can be checked:

- Document number
- Document version
- Document part

You can also determine the last and next version number.

## Use

You can use one or more methods for implementing the interface. You program the enterprise-specific requirements for the method of the Business Add-In.

## Structure

The interface of the Business Add-In includes the following method:

Method	Call	Example of a special check
DOCNUMBER_CHECK	Directly before the standard check in DMS	Enterprise-specific check for document number
DOCVERSION_CHECK	Directly before the standard check in DMS	Enterprise-specific check for document version
DOCPART_CHECK	Directly before the standard check in DMS	Enterprise-specific check for document part
DOCVERSION_GET_NEXT	When creating a new version for determining the template (source) document.	Enterprise-specific report of the last version
DOCVERSION_GET_LAST	When creating a new version for determining the next template (source) document.	Enterprise-specific report of the next version

## Integration

You implement the enhancement by using Business Add-In DOCUMENT\_NUMBER01.



## Filter for DMS processes

### Definition

Interface for an enhancement you can use to check enterprise-specific requirements you made in [processes \[Ext.\]](#). These processes can be integrated into the following functions:

- Find document (transaction CV04N)
- Web scenarios

### Use

You can use one or more methods for implementing the interface. You program the enterprise-specific requirements for the method of the Business Add-In.

### Structure

The interface of the Business Add-In includes the following method:

Method	Call	Example of a special check
BEFORE_LIST_PROCESS	Before displaying the possible processes	Enterprise-specific checks for processes and making processes available
BEFORE_LIST_STATUS	Currently not implemented	

### Integration

You implement the enhancement by using Business Add-In DOCUMENT\_PROC01.

---

**Enhancements for Internet Scenarios**

## Enhancements for Internet Scenarios

### Definition

Interface for an enhancement you can use to check enterprise-specific requirements you made in Web scenarios in the area of DMS.

### Use

You can use one or more methods for implementing the interface. You program the enterprise-specific requirements for the method of the Business Add-In.

### Structure

The interface of the Business Add-In includes the following method:

Method	Call	Example of a special check
FILTER_FILES	Before transferring document data to the IST	Checks and provision of original application files in the Web scenario
GET_URL		Determine URL for checkout in the Web

### Integration

You implement the enhancement by using Business Add-In DOCUMENT\_WEB01.

## Enhancements for Microsoft Office integration

### Definition

Interface for an enhancement you can use to check enterprise-specific requirements you made in [Office Integration \[Ext.\]](#) in the area of DMS.

### Use

You can use one or more methods for implementing the interface. You program the enterprise-specific requirements for the method of the Business Add-In.

### Structure

The interface of the Business Add-In includes the following method:

Method	Call	Example of a special check
EDIT_LINK_ITEMS	Before transferring data from the SAP System to the Microsoft Office application	Transfer of more data from the SAP System to a Microsoft Office application
AFTER_OPEN	After opening an original application file using Office integration	

### Integration

You implement the enhancement by using Business Add-In DOCUMENT\_OFFINTEGR01.

## Enhancements using User Exits (Document)

## Enhancements using User Exits (Document)

### Use

In Customizing *Document Management* you can use user exits to create enterprise-specific enhancements and extensions for document processing. You can also use them to extend the standard SAP System with enterprise-specific checks or replace standard ones.

### Integration

The enterprise-specific checks can be integrated by means of the ABAP workbench. As opposed to [Customer Exits \[Ext.\]](#) you can use user exits to access program parts and data objects of the standard system.

Some upgrades and support packages will however overwrite the modifications and they must be reentered later.



Verify after an upgrade whether enterprise-specific functions still exist or whether they cause conflicts.

### Features

The following overview lists the possibilities for customer-specific changes. The documentation is in the IMG of each activity.

Function	Activity in IMG Document Management	Notes and indications to the SAP Library
Create alternative screen	<i>Control data</i> → <a href="#">Define document types [Ext.]</a> (detail screen)	The alternative screen is only read by the <i>old</i> transactions CV01 to CV03.
Document number assignment	<i>Control data</i> → <a href="#">Define document types [Ext.]</a> (detail screen)	<b>See:</b> <a href="#">Document number [Ext.]</a>
Setting enterprise-specific additional fields	<i>Control data</i> → <a href="#">Define document types [Ext.]</a> (detail screen)	<b>See:</b> <a href="#">Additional Data for a Document [Ext.]</a>
Extensions to the object link	<i>Control data</i> → <i>Define document type</i> → Navigation step <a href="#">Determine object link [Ext.]</a>	<b>See:</b> <a href="#">Adding Other Objects [Ext.]</a> .
Executing a workflow task	<i>Control data</i> → <i>Define document type</i> → <a href="#">Define document status [Ext.]</a>	<b>See:</b> <a href="#">Overview of Additional Functions After Status Changes [Ext.]</a> <a href="#">Processing a Document Info Record (CA-DMS) [Ext.]</a>

Enhancements using User Exits (Document)

<p>Executing enterprise-specific program routines</p>	<p><i>Control data</i> → <i>Define document type</i> → <a href="#">Define document status [Ext.]</a></p>	<p><b>See:</b> <a href="#">Overview of Additional Functions After Status Changes [Ext.]</a></p>
---	--	---

## Enhancements Using Customer Exits (Material Master)

## Enhancements Using Customer Exits (Material Master)

### Use

To optimize work flows, you can use [customer exits \[Ext.\]](#) to change some of the functions in the standard material master.



SAP Enhancement MGA00003 makes it possible to edit the display of material numbers as required. For example, if a material is assigned the number 123, you can use this enhancement to define that the material number is displayed with a prefix such as MAT-, even though the number in the database is still 123.

For more information, see the SAP library documentation *Changing the SAP Standard (BC) Customer Exits [Ext.]*.

### Features

The following overview shows the enhancements defined for customer exits in the material master.

#### Enhancements for Function Group XMG0 (General)

Use	Enhancement	Function Module
Extending and adding checks, and (to a restricted extent) changing data	MGA00001	EXIT_SAPLMGMU_001 (enhancements for material master tables)
Influencing how material numbers are assigned	MGA00002	EXIT_SAPLMG02_001 (internal number assignment)  EXIT_SAPLMG02_002 (external number assignment)

**Enhancements Using Customer Exits (Material Master)**

Influencing how material numbers are displayed	MGA00003	EXIT_SAPLOMVCV_001 (number conversion from display format to DB format (input: start))  EXIT_SAPLOMVCV_002 (number conversion from display format to DB format (input: end))  EXIT_SAPLOMVCV_901 (number conversion from DB format to display format (output: start))  EXIT_SAPLOMVCV_902 (number conversion from DB format to display format (output: end))
--	----------	--

**Enhancements for Function Group XMGV (Distribution of Material Master Data by ALE)**

Use	Enhancement	Function Module
ALE distribution	MGV00001	EXIT_SAPLMV01_002 (IDoc creation)  EXIT_SAPLMV02_002 (IDoc posting)

**Enhancements for Function Group XMG3 (Filter Objects for Material Master Distribution)**

Use	Enhancement	Function Module
Reading customer-defined filter objects for a material	MGV00002	EXIT_SAPLMV03_001

**Additional Information**

In the SAP library documentation [Material Master \(LO-MD-MM\) \[Ext.\]](#):

- [Material Numbers \[Ext.\]](#)
- [Transfer and Distribution of Material Master Data \[Ext.\]](#)

## Enhancements in the Area Engineering Change Management

## Enhancements in the Area Engineering Change Management

### Use

You can change some functions in the area of Engineering Change Management (ECH) with the use of [Customer Exits \[Ext.\]](#) in order to optimize your work processes.



When the person responsible saves a change master record you may want to run self-defined checks to discover any discrepancies in the data and also to keep this data from being saved on the database. You create an enhancement project by using the enhancement PCCD0004 (*Check before saving a change number*). The enhancement contains the function module EXIT\_SAPMC29C\_005. This exit refers to the include program ZXCCAU05. Enter the program code in the include program.

### See also:

[Enhancements to the SAP System in the Area of PDM \[Page 122\]](#) and [The SAP System Enhancement Concept \[Ext.\]](#)

### Prerequisites

When you use a function exit you must create an enterprise-specific include program that fits the program logic of the appropriate function module.

### Features

The following overview shows the enhancements that are supported for the customer exits in the area of Engineering Change Management (ECH) (development class CC).

#### Enhancements for the Function Group XCCA

Description	Enhancement	Function Module
Customer field in the change master	PCCD0001	EXIT_SAPMC29C_001 EXIT_SAPMC29C_002
Check of the values of parameter effectivity	PCCD0002	EXIT_SAPMC29C_003
Check when setting a system status	PCCD0003	EXIT_SAPMC29C_004
Check before setting the change number	PCCD0004	EXIT_SAPMC29C_005
Check at initial screen	PCCD0005	EXIT_SAPMC29C_006

The documentation for the individual customer enhancements can be found in each of the enhancements itself in the SAP System. The following shows how to access the documentation for individual customer enhancements:

1. Go to *Tools* → *ABAP Workbench* → *Help* → *Enhancements* → *Definition*.
2. Enter the name of the customer enhancement.
3. Highlight the *Documentation*, option and select  *Display*.



---

Enhancements in the Area Engineering Change Management

## Enhancements in BOMs

## Enhancements in BOMs

### Use

You can display workflows in the *BOM* area, in a company-specific way, using various enhancement options.



Information about the enhancement options as well as an overview of the planned enhancements for SAP objects in PDM is contained in [Enhancements of the SAP System in PDM \[Page 122\]](#)

### Features

The following overview displays the enhancement options for the standard SAP System in *BOMs*.

Enhancement Options	Implementation
<a href="#">Enhancements using Customer Exits [Page 163]</a> <b>See also:</b> <a href="#">Customer Exits [Ext.]</a>	You can display the processing of BOMs in a company-specific way using Customer Exits.
<a href="#">Enhancement using business transaction events [Page 165]</a>	You can write separate programs that are performed when specific events are triggered in the standard SAP System.

## Enhancements Using Customer Exits (BOMs)

### Use

In order to optimize the BOM processing processes in your business, you can change some functions of the SAP System in *BOMs* by using [Customer Exits \[Ext.\]](#).



If an administrator enters a new item in a BOM, you want the system, for example, to automatically check whether the material entered is allowed in this BOM. You create an enhancement project where you use the enhancement PCSD0005 (*component check for material items*). The enhancement contains the function module EXIT\_SAPLCSDI\_006. This links to the include program ZXCSAU10. Enter your program code into this include.

**See also:**

[Enhancements of the SAP System in the Area of PDM \[Page 122\]](#) and [Customer Exits \[Ext.\]](#)

### Prerequisites

When you use a function exit, you must create a company-specific include program that matches the programming logic of the function module.

### Features

The tables below show the enhancements for customer exits used in BOMs (development class CS).

**Enhancements for Function Group XCSA**

Description	Enhancement	Function Modules
Enhance maintenance of material BOMs	PCSD0001	EXIT_SAPLCSDI_001
Customer fields in item	PCSD0002	EXIT_SAPLCSDI_002 EXIT_SAPLCSDI_003
Customer fields in header	PCSD0003	EXIT_SAPLCSDI_004 EXIT_SAPLCSDI_005
BOM comparison	PCSD0004	EXIT_RCS14001_001 EXIT_RCS14001_002 EXIT_RCS14001_003
Component check for material items	PCSD0005	EXIT_SAPLCSDI_006
Mass Changes	PCSD0006	EXIT_SAPMC29M_001
Check on the changes to BOM header	PCSD0007	EXIT_SAPLCSDI_007
WBS BOM: Customer-specific explosion during create	PCSD0008	EXIT_SAPLCSWB_001

**Enhancements Using Customer Exits (BOMs)**

Determine standard URL for BOM browser	<a href="#">PCSD0009 [Ext.]</a>	EXIT_SAPLCSSO_001
BOM browser: Determine Explosion Date	<a href="#">PCSD0010 [Ext.]</a>	EXIT_SAPLCSSO_002
Knowledge Based Order BOM: Parallel Updates	<a href="#">PCSD0011 [Ext.]</a>	EXIT_SAPLCSSF_001
Customer material number/material type during material exchange	<a href="#">PCSD0012 [Ext.]</a>	EXIT_SAPLCSME_001
Customer specific processing of an explosion for the BOM browser	<a href="#">PCSD0013 [Ext.]</a>	EXIT_SAPLCSSO_003

You can find the documentation for the individual customer enhancements in the appropriate enhancement in the SAP System. To display the documentation for the individual customer enhancements you:

4. Choose *Tools* → *ABAP Workbench* → *Utilities* → *Enhancements* → *Definition*.
5. Enter the name of the customer enhancement.
6. Select *Documentation*, and click on  *Display*.

## Enhancements using Business Transaction Events (BOMs)

### Use

In order to optimize *BOM* processes in your enterprise you can use Business Transaction Events to enhance the processing functions of the standard SAP System.

Business Transaction Events are defined parts within a source that can add coding for different software levels, such as branches, partners, or customers, without changing the original program itself.

You use Business Transaction Events, to enhance the standard SAP System with extra components. You can link in-house function modules, or a product from a third party, to the standard SAP System.

**See also:**

[Using Business Transaction Events \[Ext.\]](#)

### Features

Enhancement interfaces are defined in coding of the standard SAP System. If an event is triggered, the system calls up the function modules in which the customer-specific coding is executed.

The tables below show the enhancements for Business Transaction Events used in BOMs (development class CS).

**Enhancements for Function Group CSBE**

Description	Event SAP-Function Module	Sample Module for Customer Module
<a href="#">Update Bills of Material [Page 166]</a>	CS000010 OPEN_FI_PERFORM_CS000010_E	SAMPLE_INTERFACE_CS000010

### Activities

1. Create your own function modules (customer modules).  
At the same time, copy the sample module as a template.
2. Enter your program code into the customer modules.
3. In table TBE11 activate the application CS.  
This has to be done before the SAP function module calls up the customer modules.
4. Assign an event to each customer module in the table TBE34.  
If the event is triggered, the system calls up the customer modules, which are assigned to the event in this table.

---

**Update of a BOM (CS000010)**

## Update of a BOM (CS000010)

### Use

You use this Business Transaction Event to start additional in-house programs during a BOM update.



For example, you can start up external software to check a BOM against your own consistency rules.

### Features

The function module `OPEN_FI_PERFORM_CS000010_E` is called up when the user saves a BOM, but before the system updates the data in the database.

The customer modules are called up using the function module `OPEN_FI_PERFORM_CS000010_E`.

All data for the corresponding BOM is transferred to the customer module.

### Constraints

The interface does not return any data to the standard SAP System.

## Enhancements in the Classification System

### Use

In order to optimize the business processes in the classification system, you can change some classification functions of the SAP System by using customer exits.



If a user in characteristics maintenance has not maintained default values for finding objects, you can use enhancement CLCTMS01 (*Default values for finding objects*) to define default values in a table or add further values. The enhancement contains the function module EXIT\_SAPLCTMS\_001. This links to the include program ZXCTMSU01. Enter your program code in this include.

**See also:**

[Enhancements to the SAP System in the Area of PDM \[Page 122\]](#)

[Customer Exits \[Ext.\]](#)

### Prerequisites

When you use a function exit, you must create a company-specific include program that matches the programming logic of the function module.

### Features

The following is an overview of the enhancements supported in the classification system (development class CL).

Description	Enhancement	Function Modules	Include
Default values for finding objects	CLCTMS01	EXIT_SAPLCTMS_001	ZXCTMSU01
Check for same classification	CLCTMS02	EXIT_SAPLCTMS_002	ZXCTMSU02
Change or predefine classification of an object	CLFM0001	EXIT_SAPLCLFM_001	ZXCLFU01
Call before updating classification data	CLFM0002	EXIT_SAPLCLFM_002	ZXCLFU02
Selection of objects for mass processing	CLMMD001	EXIT_SAPLCLMMD_001	ZXCLMMDU01
Manipulation of the search result	CLSC0001	EXIT_SAPLCLSC_001	ZXCLSCU01
Object dependencies in object search	CLCTMS03	EXIT_SAPLCTMS_003	ZXCTMSU03

The documentation on individual customer enhancements is in the SAP System with the enhancements themselves. To display the documentation on a customer enhancement:

1. Choose *Tools* → *ABAP Workbench* → *Utilities* → *Enhancements* → *Definition*.

**Enhancements in the Classification System**

2. Enter the technical name of the customer enhancement.
3. Select *Documentation* and choose  *Display*.



## Enhancements in Variant Configuration

### Use

In order to optimize the business processes in variant configuration, you can change some variant configuration functions of the SAP System by using customer exits.



If a user works with very complex, multilevel configurations, you can control the level of detail shown for the configuration. You can use enhancement CCUX0800 to determine whether all assemblies are exploded or only the configurable assemblies. The enhancement contains function module EXIT\_SAPLCUKO\_002. This links to include program ZXCUCU05. Enter your program code in this include.

**See also:**

[Enhancements to the SAP System in the Area of PDM \[Page 122\]](#)

[Customer Exits \[Ext.\]](#)

### Prerequisites

When you use a function exit, you must create a company-specific include program that matches the programming logic of the function module.

### Features

The following is an overview of the enhancements supported in variant configuration (development class CU).



Constant additions are being made to customer enhancements for variant configuration and this documentation may not include all the possible enhancements. To see the most up-to-date list of enhancements call the F4 help for *Enhancements* and the *Development class CU\** for *Infosystem*.

Description	Enhancement	Function Modules	Include
Variant configuration: external APIs	CAVC0000	EXIT_SAPLCAVC_CFG_001 EXIT_SAPLCAVC_INST_001 EXIT_SAPLCAVC_INST_002	ZXCAVCU01 ZXCAVCU02 ZXCAVCU03
Customer-specific batch-input processing	CCUCEI0B	EXIT_SAPLCEI0_020	ZXCEI0U12
Processing of planning tables	CCUP0001	EXIT_SAPLCUD2_800 EXIT_SAPLCUTS_800	ZXCUPU02 ZXCUPU01
Additional checks on configurations	CCUX0000	EXIT_SAPLCUKO_001	ZXCUCU02
Functions for loading configurations	CCUX0001	EXIT_SAPLCUD0_001 EXIT_SAPLCUXC_001	ZXCUCU01 ZXCUCU03

## Enhancements in Variant Configuration

Reaction to conflict when finding an object for a class node	CCUX0002	EXIT_SAPLCUD0_002	ZXCUCU04
Parameters for finding an object for a class node	CCUX0003	EXIT_SAPLCEIS_001	ZXCUCU17
Postprocessing of configuration with object dependencies	CCUX0004	EXIT_SAPLCUKO_003	ZXCUCU07
Transfer of item category after material variant matching	CCUX0005	EXIT_SAPLCEB1_001	ZXCUCU10
Fixing an order BOM	CCUX0006	EXIT_SAPLCUKO_007	ZXCUCU13
Definition of the BOM category for instantiation	CCUX0007	EXIT_SAPLCEB1_002	ZXCUCU14
No BOM explosion for externally procured components	CCUX0008	EXIT_SAPLCUKO_008	ZXCUCU15
Synchronization of initialization of variant configuration	CCUX0100	EXIT_SAPLCUD0_003	ZXCUIU01
Configuration: Additional processing for changing variant table contents	CCUX0510	EXIT_SAPLCUD3_001	ZXCUTU02
Effectivity date for order BOM	CCUXDATE	EXIT_SAPLCASL_002	ZXCUC1U03
Control of the level of detail in multilevel configurations	CCUX0800	EXIT_SAPLCUKO_002	ZXCUCU05
Explosion date for result-oriented order BOMs	CCUXDATU	EXIT_SAPLCASL_001	ZXCUC1U01
Maintenance of additional data for instantiation	CCUXIACD	EXIT_SAPLCEB1_100	ZXCUC1U02
Effectivity date for order BOM	CCUXDATE	EXIT_SAPLCASL_002	ZXCUC1U03
Modification for external number assignment for instantiation	CCUXINST	EXIT_SAPLCUKO_004	ZXCUCU09
Find material variants with the same value assignment	CCUCEI0V	EXIT_SAPLCEI0_023	ZXCI0U15
Assigned values file and object characteristics	CCUCEI0A	EXIT_SAPLCEI0_021	ZXCEI0U13
Change F4 help for characteristics in configuration	CCUCEI0H	EXIT_SAPLCEI0_022	ZXCEI0U14
Object types for finding objects for class nodes	CCUXOBTY	EXIT_SAPLCEIS_002	ZXCUCU19

Enhancements in Variant Configuration

Definition of the BOM status for instantiated materials	CCUXSTAT	EXIT_SAPLCEB1_003	ZXCUCU16
Multilevel configuration with material variants	CCUXMVAR	EXIT_SAPLCUKO_009	ZXCUCU20
Component quantity for set development	CCUXSETQ	EXIT_SAPLCUKO_010	ZXCUC2U01
Availability of customer functions in the configuration editor	CEI00000	EXIT_SAPLCEI0_010 through EXIT_SAPLCEI0_019	ZXCEI0U01 ZXCEI0U02 ZXCEI0U03
Configuration: Determine superior material	CUBX0001	EXIT_SAPLCUBX_001 EXIT_SAPLCUBX_002 EXIT_SAPLM60P_003	ZXCUBXU01 ZXCUBXU02 ZX60PU03
Additional logic deleting classification data from the LO-VC view	CUCPDELE	EXIT_SAPLCLDL_002 EXIT_SAPLCUCP_003 EXIT_SAPLCUCP_004 EXIT_SAPLCUCP_005	ZXCUCPU01 ZXCUCPU02 ZXCUCPU03 ZXCUCPU04
Additional logic deleting classification data from the LO-VC view CBASE	CUCPDEL1	EXIT_SAPLCUCP_006 EXIT_SAPLCUCP_007 EXIT_SAPLCUCP_008	ZXCUCPU05 ZXCUCPU06 ZXCUCPU07

The documentation on individual customer enhancements is in the SAP System with the enhancements themselves. To display the documentation on a customer enhancement:

4. Choose *Tools* → *ABAP Workbench* → *Utilities* → *Enhancements* → *Definition*.
5. Enter the technical name of the customer enhancement.
6. Select *Documentation* and choose  *Display*.

**See also:**

[Specifying Enhancements in the Configuration Editor \[Ext.\]](#)

---

**WBS BOM Browser**

## WBS BOM Browser

### Definition

Navigation tool for displaying a multi-level BOM of a WBS element.

### Use

You use the WBS BOM browser if you work as a make-to-order producer such as in plant engineering and construction with the project system and WBS BOMs.

Since each project has different requirements, you want to modify your material BOMs to a specific project. If you have created a WBS element for an assembly, you can create a WBS BOM for the assembly. In the WBS BOM, you carry out the project-specific modifications. The changes that you make to a WBS BOM only apply to this project and for this WBS element. If you change a WBS BOM, the corresponding material BOM remains unchanged.

In the WBS BOM browser, you get an overview of the current processing status of the multi-level WBS BOM in a central screen area, and you navigate to the processing and reporting functions for WBS BOMs.

### Structure

In the WBS BOM browser the multi-level BOM is displayed in a similar way as to in the [product structure browser \[Ext.\]](#). As you do there, you can see an overview tree, whose branches you can reveal and hide. In contrast to the product structure browser, only the BOM headers and items are displayed in the overview tree.

## Navigation in the WBS BOM Browser

### Use





In the WBS BOM browser display the multi-level BOM for a WBS element and navigate to the processing and reporting functions for WBS BOMs.

### Features

#### Object-specific functions

You call up the object-specific functions from symbols in the overview tree as well as from the context menu.

#### Symbols in the overview tree

Symbol	Description	By clicking ...
	BOM header	On the right mouse button, you display the context menu with the processing functions for WBS BOMs.
	BOM item	
	Subordinate assembly has a material BOM	
	Subordinate assembly has a WBS BOM	
	Original exists (only document item)	You display the original file.

By clicking on the right mouse button, you call up the **context menu** for a BOM header or a BOM item. The functions that can be carried out in the processing situation are listed in the context menu.

#### Display functions

- Expand everything
- Collapse partial tree
- Display (item overview or item detail screen)
- Expand in a new window of the WBS BOM browser

#### Processing functions

- BOM transfer into the project system  
[BOM transfer into the project system \[Ext.\]](#)
- Create WBS BOM (for BOM items)
- Material exchange (for material BOMs)

**Navigation in the WBS BOM Browser**

[Material Exchange \[Page 69\]](#)

- Fixing – single-level (for material BOMs)





[Fixing \[Page 71\]](#)

- Fixing – multi-level (for material BOMs)
- Change (for WBS BOMs)
- Change with change number (for WBS BOMs)

**General functions**

In the application function list, you call up the functions of the entire multi-level WBS BOM.

**Symbols in the application function list**

Symbol	Function	Description
	Find	Generic search function
	Print	Prints out the content of the browser.
	Layout	Reveals a dialog box in which you can determine the information displayed in the overview tree.
	Find object	Reveals a dialog box for you to find materials, documents and classes in the overview tree. The system automatically expands the subtree in which the searched for object was found and highlights it.
	Refresh	Explodes the BOM and refreshes the display in the overview tree.

From the menu *Goto* you go to the WBS element and to the project info system as well as to the reporting functions for the WBS BOMs.

## Calling Up the Browser from the Project Info System

You call up the WBS BOM browser from the project info system as follows:

1. With the right mouse button, click in the project info system on a WBS element.
2. In the context menu that appears, select *BOM*.

You see the initial screen of the WBS BOM browser.

In the right hand screen area, the system displays a list of all the available WBS BOMs for the selected WBS element.

3. Double click on one of the available WBS BOMs and select .

## Calling up the Browser

## Calling up the Browser

- From the SAP Easy Access menu, choose *Logistics* → *Production* → *Master data* → *Bills of material* → *Bill of material* → <BOM type> → *Multi-level* → *Browser*.

You see the initial screen of the browser.

- Enter the identified data for the BOM, the BOM application and also a date or a change number.

If you enter a change number here, the system uses this change number to explode the multi-level BOM in the overview tree. The change number on the initial screen of the browser is **not** valid for changes that you then carry out to the single-level BOM.



If you click  the system displays a list of the last ten BOMs displayed in the browser.



If you now click  the system displays other data from the environment of the selected BOM on the initial screen.

- If you are working with large BOMs and only want to display the assembly on the top level of the multi-level BOM, enter a value for the maximum explosion level.
- Click on  to enter the settings for explosion and display. You can

- Define the view. For more information, see the component *PS – Project System* under [Define view for BOM explosion \[Ext.\]](#).
- Restrict the view.
  - Using the indicator *Ltd Explosion* (Limited Explosion) you can select whether BOM items kept in stock should be exploded further. For more information, see the component *PP - BOMs* under [Restrict view for BOM explosion \[Ext.\]](#).
  - Using the indicator *Var. Display Depth* (Variable Display Depth) you can specify that only a section of the multi-level BOM is displayed in the order browser. You can find further information in [Variable display depth \[Page 178\]](#).
- Specify whether the multi-level BOM should be automatically up-dated after each processing step.
- Select whether the overview tree and the processing functions are displayed in the same window.

If you do this, the overview tree is displayed in the left or top screen area. If in the context menu of a BOM header or of a BOM item you select a processing function, the system displays this function in the right or bottom screen area.



Before you switch to another processing function remember to save, or click .

- Click .





## Variable Display Depth

## Variable Display Depth

### Use

In the design, you do not usually process the entire multi-level BOM for a sales order item but rather you concentrate on a specific assembly. You often do not want to display the entire multi-level BOM for a sales order item in the overview tree of the order browser, rather only the subtree for the assembly you want to process.

### Prerequisites

You have set the *Variable disp. depth* (Variable display depth) indicator in the dialog box *Order browser: Settings*.

### Features

When you call up the order browser, the *Display Depth* dialog box appears. There, you select the material number of the assembly at the head of the subtree that you want to display.

If you want to display another subtree at a later date, click on , to go back to the *Display Depth* dialog box.

The following functions are available in the *Display Depth* dialog box:

Function	Procedure	Notes
Display subtree	Enter the material number for the assembly at the head of the subtree. Use the possible entries function to do this, if necessary.	If an assembly in the multi-level BOM is used on various different nodes, you can clearly identify a node using the information on levels and nodes in the entry help.
Displaying the whole multi-level BOM	Deselect the <i>Retain Variable disp. depth</i> indicator.	This results in the <i>Display Depth</i> dialog box no longer being displayed during the current session.



In the initial node the system displays the material for the sales order item in all processing situations. This is also the case when you only display a subtree.

### Activities

#### Activating Variable Display Depth

You activate variable display depth as follows:

You are in the initial screen of the browser.

2. Click .
3. The *Settings* dialog box appears.
4. Set the *Variable disp. depth* indicator.

5. Click 

## Display Log

# Display Log

## Use

If you execute one of the following functions in the browser, the system creates a log:

- Material exchange
- Fix – single-level
- Fix – multi-level

With the help of the log you can see which activities the system has carried out using these functions.

## Activities

In order to display the log choose *Extras* → *Logs*. You can choose which logs are displayed:

Function	Description
 <i>Current Log</i>	Displays the last log generated.
<i>Today's Log</i>	Displays all the logs for the BOM functions that the logged-on user has executed during the day.
<i>All Logs</i>	Displays a selection screen in which you can look for any log

## Analysis

### Use

You carry out an analysis if you want to get an overview of all assemblies to a WBS element.

### Features

During analysis, the assemblies to a WBS element are displayed on various tab pages:

- WBS BOMs  
All the WBS BOMs that exist for a WBS element.
- WBS root  
If for a WBS element you have several assemblies independent of each other, you can create a multi-level WBS BOM for each of these assemblies. All assemblies that are the header of a multi-level WBS BOM for a WBS element, are displayed on these tab pages:
- Material BOMs  
All BOMs that have not been saved to a specific project.
- BOM header not valid  
WBS BOMs whose header is invalid on the *Valid-from* date on the initial screen
- Multiple assemblies  
Assemblies that are used on multiple occasions in the multi-level WBS BOM.

### Functions of list

The BOMs are called up in a list on the individual tab pages. For this list, various functions are available such as:

- Sort
- Filter
- Print
- Export (such as into spreadsheet)

For more information, see [ABAP List Viewer \(ALV\): Grid Control \[Ext.\]](#).

### Activities

If you are in the WBS BOM browser, select  *Analysis*.

---

**Material Exchange in the WBS BOM Browser**

## Material Exchange in the WBS BOM Browser

### Use

You exchange the material to a node of a multi-level WBS BOM if you want to carry out different changes to an assembly that is used on various levels in one of the multi-level BOMs to a WBS element.

### Prerequisites

The BOM whose header material you exchange, must be a material BOM.

The superior BOM, that means the BOM that contains the components to be exchanged, has to be a WBS BOM.

### Features

The system creates a new material master record and **for the selected nodes** a WBS BOM. Consequently, data is copied from the original material master record and items are copied from the original BOM.

You can select the scope of the data to be copied:

- If you only transfer the *basic data for a plant*, the system copies the basic data and the MRP data for the plant from the material master. You get a material master record that only contains the data that is required for a material exchange. You can enhance this material master record manually.
- If you select *maximum transfer*, the system also copies additional data that is available in the original material master record, such as sales and distribution and costing data. Consequently only the data for the plant or, if not available, the group data is copied.

## Material Exchange

### Prerequisites

The superior assembly must already have been saved as order or project-specific.

### Procedure

2. Select the BOM header whose material you want to exchange.
3. Open the BOM header context menu with the right mouse button and select *Material Exchange*.

The *Setting Material Data* dialog box appears.

4. Select which data you want the system to create in the material master.
  - Basic data for plant
  - Maximum transfer

5. Enter a material number and a description for the new material.

If you do not enter a material number, the system assigns a material number from an internal number range.

6. Click .

The system carries out the material exchange.

### Result

The system

- Creates a new material master record with the new material number
- Copies the BOM for the previous material and saves it as an order BOM, whose header is then assigned the new material number
- Replaces the previous component in the superior order BOM item with a component that has the new material number
- Writes a [log \[Page 180\]](#), in which system activities during the material exchange are documented.

---

**Fixing a BOM in the WBS BOM Browser**

## Fixing a BOM in the WBS BOM Browser

### Use

You fix a material BOM if you want to make project-specific changes to the BOM.

### Features

If you fix a BOM, the system creates a project-specific copy of the material BOM, which means it generates a WBS BOM from a material BOM.

You can fix a single or multi-level BOM. If you fix a BOM **single level** the system creates exactly one WBS BOM.

If you fix a BOM **multi-level**, the system also generates project-specific copies for all subordinated material BOMs (TopDown). The BOM, with which you carry out the multi-level fixing, must be a material BOM. The system creates WBS BOMs for all material BOMs in the subtree. If a subordinate assembly already has a WBS BOM, the system does not change this. If, however, material BOMs can still be found below such a WBS BOM, these are fixed accordingly.

### Activities

In the context menu of the BOM header, select the command *Fix BOM – single-level* or *Fix BOM – multi-level*.



## Processing a Single-Level WBS BOM

### Use

You change a WBS BOM with this function.

### Prerequisites

You have fixed a material BOM or created a WBS BOM manually.

The same prerequisites apply here as for the processing of material BOMs. For more information, see the component *BOM* under [Before making a change \[Ext.\]](#).

### Features

If you create project-specific components in a WBS BOM, you work as you would for processing a material BOM.

You can enhance a WBS BOM by transferring items from an existing WBS BOM or from a material BOM.



Several people can simultaneously process different assemblies of a multi-level BOM. However, a specific assembly can only be processed by one person at a particular time. Therefore, this assembly is locked to other people until it is saved.

The following restrictions apply for WBS BOMs:

- You can not create a [BOM alternative \[Ext.\]](#) for a WBS BOM.
- You can not create a [variant BOM \[Ext.\]](#) for a WBS BOM.
- If you change a WBS BOM, you can work with change numbers but not with revision levels.



After processing a WBS BOM, select , so that the system can update the current components of a WBS BOM.

### Activities

In the context menu of the BOM header, select the command *Change* or *Change with change number*.

---

**BOM Transfer**

## BOM Transfer

### Use

You carry out a BOM transfer in order to assign specific components to network operations and to update the assignments. For more information, see the component *PS – Project System* under [BOM transfer \[Ext.\]](#).

If you want to procure an assembly that has a long replenishment lead time, before the design for the entire product is complete, you carry out a BOM transfer in order to generate preliminary requirements. In this case, be aware of the note under [Advance procurement \[Ext.\]](#) in the component *PS – Project System*.

### Prerequisites

You have maintained the reference points in the BOM items and in the network. For more information, see [Maintain reference points in the BOM item \[Ext.\]](#) and [Maintain reference points in the network operation \[Ext.\]](#).

Furthermore, the general prerequisites apply for the BOM transfer into the project system. For more information, see the component *PS – Project System* under [BOM transfer \[Ext.\]](#).

### Procedure

You are in the WBS BOM browser.

1. If necessary, select , to ensure that you are using the current processing status.

The system re-explodes the multi-level BOM.

2. Select the header of the BOM for which you want to carry out the BOM transfer.
3. In the context menu of the BOM header select *BOM transfer PS*.

You see the *BOM Transfer* screen. The following fields are already preassigned and are not ready for input:

- WBS element
- Material
- Plant
- BOM Usage

In the following fields you find default values that you can overwrite:

- BOM type (material BOM or WBS BOM)
- BOM application
- Requirements quantity

4. Enter the data that is not yet preassigned and click .

